

Pro Pilot



Operation Manual

Trio Avionics Corporation

Manual Part Number 13200012

Notice: This manual uses illustrations that generally show the Pro Pilot model that mounts in a standard 3-1/8" round cutout in the instrument panel. However, all functions are duplicated in the stack mount version of the Pro Pilot. The instructions herein are valid for both systems with the following exceptions:

- The stack mount Pro Pilot requires an external power switch or breaker.
- The stack mount Pro Pilot does not include a slip-skid indicator

Note: *While the autopilot has the capabilities detailed in this manual, limitations for altitude and approaches may have been imposed by the FAA. Check the AFMS (Airplane Flight Manual Supplement) for your particular aircraft on the web site of The STC Group, LLC. (www.thestcgroupllc.com/documents)*



Note: The #6 screws that are used to mount the 3-1/8" round control head to the instrument panel must not penetrate more than 3/8 inches into the control head. Tightening longer screws will result in damage to the control head which will not be covered by warranty.

Note: The stack mount control head requires a 1.5 mm Allen head wrench to insert or remove it from the sleeve.

© Copyright 2024
Trio Avionics
All Rights Reserved

Except as expressly provided herein, no part of this manual may be reproduced, copied, transmitted, disseminated, downloaded or stored in any storage medium, for any purpose without the express prior consent of Trio Avionics.

Trio Avionics
1905 N. Marshall Ave.
#6
El Cajon, CA 92020

Table of Contents

Pro Pilot Control Head Diagram.....	6
Chapter 1 Horizontal Navigation Overview (HNAV).....	7
GPS Requirements.....	7
Operation.....	7
Basic H NAV Operation Modes.....	7
Track Mode (TRK).....	8
Course Mode (CRS).....	8
Intercept Mode (INT).....	9
Chapter 2 Vertical Navigation Overview (VNAV).....	10
Operation.....	10
Basic V NAV Operation Modes.....	10
Altitude Hold.....	10
Vertical Climb/Descent.....	11
Airspeed Capture and Control (using PCS).....	11
Altitude Pre-Select.....	11
Chapter 3 Control and Display Overview.....	12
Switch Function and Operation.....	12
ON/OFF Switch.....	12
Operation.....	12
H MODE and V MODE buttons.....	13
Roll (H NAV) & Pitch (V NAV) Servo Activation.....	14
Remote Disconnect Switch.....	14
Rotary Encoder - Pushbutton Switch.....	14
The Display Arrow.....	14
H MODE Encoder Functions.....	15
V MODE Encoder Functions.....	16
Chapter 4 Preflight Power Up.....	18
Chapter 5 Information Fields.....	19
Horizontal Navigation (H NAV).....	19
Power up Display.....	19
Initial Logo Screen.....	19
ELEVATION SET Screen.....	19
NO GPS Screen.....	19
Normal Power Up Display, GPS Active.....	19
Track Display Information.....	20
Bearing To Waypoint Field (BTW).....	20
Ground track Field (GTK).....	20
Variable Field, Top Line.....	20
Cross Track Error Field (XTK).....	20
Other Available Fields on the Bottom Line.....	21
Groundspeed (GS).....	21
Estimated Time En Route, HH:MM (ETE).....	21
Estimated Time En Route, MM:SS (ETe).....	21

<i>Range to a Waypoint (RNG)</i>	22
<i>Waypoint</i>	22
<i>Digital Rate of Turn Display</i>	22
Automatic Field Scan Mode.....	22
GPS Data Anomalies	22
<i>DIS?</i>	22
<i>TRN?</i>	22
<i>SPD?</i>	23
Chapter 6 Horizontal Operation	24
Track Mode (TRK).....	24
Tracking a Course (CRS).....	24
<i>Using Course Mode</i>	24
Intercept a Course (INT).....	25
<i>Intercept Operation</i>	25
Selecting a Track Offset Position (TOP).....	26
Initiating the Recover Mode.....	27
Initiating an Automatic Course Reversal	27
Variable Display Field – Top Line.....	28
Corrupted GPS Data Stream.....	28
Chapter 7 Horizontal Flight Examples	29
Flying to a Course line (DTK) or GOTO Waypoint	29
Loss of GPS	29
Course Mode Example	30
Intercept Mode Example	31
Horizontal Use of Pilot Command Steering (PCS).....	31
Chapter 8 Vertical Operation	33
Vertical Navigation (V NAV)	33
Altitude Hold (ALT HLD)	33
Setting Vertical Speed (SET VS).....	34
Altitude Pre-Select Function (ALT SET)	35
Entering the Current Altitude	36
<i>Barometer Elevation/Altitude Set</i>	36
Entering a Destination Altitude.....	36
<i>Pausing the Climb Example</i>	37
<i>Changing the Destination Altitude</i>	38
A Vertical Flight Scenario.....	38
Vertical Use of Pilot Command Steering.....	40
Trim Alerts.....	40
Clutch Slip Alert.....	40
Chapter 9 GPSS and GPSV Operation.....	41
GPSS and GPSV Defined.....	41
<i>GPSS and GPVS Considerations</i>	41
Operation Using Certified WAAS GPS Receivers	41
<i>GPSS Guidance</i>	41
GPSS LED Indicator.....	42
<i>GPSV Guidance</i>	42
Approaches	42
<i>Unusual Conditions</i>	43
Example Approach Scenario	44
Chapter 10 Autopilot Preferences Menu	45

Using the Preferences Menu	45
Settings Available In the Preferences Settings Menu.....	45
Backlight Set and Display Brightness Set	45
Flight Distance and Flight Time	46
Accumulated Total Distance, Total Flight Time	46
Circle Last Waypoint Setting	47
Set Default Vertical Speed Rate.....	47
Selecting Airspeed or Vertical Speed for PCS.....	48
Setting Maximum Turn Rate	48
Zero Flight Data on Startup.....	49
Custom Startup Display Screen	49
Chapter 11 Dynon /Aspen / Garmin G5 Integration.....	51
Chapter 12 Alerts, Warnings and Alarms.....	57

Pro Pilot Control Head Diagram

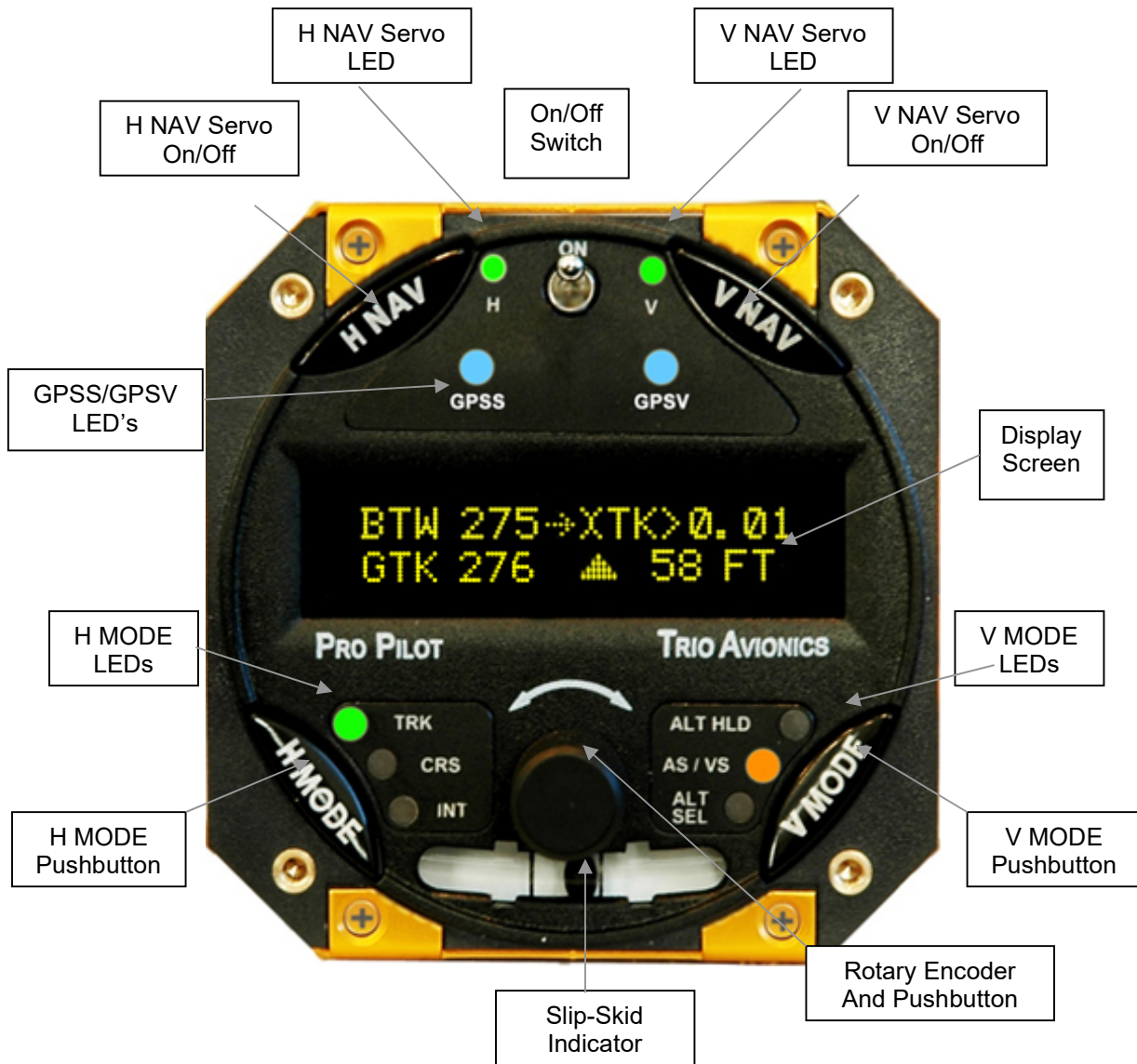

Pushbuttons

H NAV - Horizontal Navigation (Activates/Deactivates Roll Servo)
V NAV - Vertical Navigation (Activates/Deactivates Pitch Servo)
H MODE - Sequences through Horizontal Navigation Modes
V MODE - Sequences through Vertical Navigation Modes

Chapter 1

Horizontal Navigation Overview (HNAV)

The **H NAV** function of the Pro Pilot controls the roll axis servo for attitude correction (wing leveling) and provides horizontal navigation using signals from a GPS receiver or EFIS system.

GPS Requirements

The Pro Pilot does not contain a built-in GPS or other navigation data source. It is necessary that an appropriate host GPS source be supplied and correctly connected to the Control and Display Head at the time of installation. (See the Installation Instructions later in this manual.)

The Pro Pilot uses a solid-state inertial rate sensor for attitude stabilization. It uses elements of the host GPS digital data stream for the navigation function. It accepts either a NMEA 0183, V2.XX stream format or the Aviation Link format for navigation guidance. An ARINC 429 interface is included to enable the GPSS and GPSV options.



Note: The Pro Pilot also uses the GPS derived information to monitor the inertial sensor performance and provides automatic corrections to the sensor data to correct for drift due to thermal shifts, inherent sensor drift and noise errors. The Pro Pilot has a flash based EEPROM memory that is updated automatically with the most current dynamic calibration information during each flight.

Operation

While the Pro Pilot is an excellent “wing leveler,” its greatest strength is following an active flight plan from a GPS source. This can be as simple as a “GOTO” a waypoint as commanded by the GPS, or a complex, multi-segment flight plan.

Three horizontal navigation modes allow the pilot to follow a selected GPS course or flight plan.

Basic H NAV Operation Modes

The capabilities of the **H NAV** system comprise four basic modes:

- 1.) Track Mode (**TRK**) tracks a GPS directed flight plan course line.
- 2.) Course Mode (**CRS**) tracks a pilot directed heading.
- 3.) Intercept Mode (**INT**) flies the airplane back to a previously entered course line.
- 4.) When directed, execute a **180-degree course reversal** or a straight ahead **RECOVER** function

Track Mode (TRK)

The track mode (**TRK**) is used for automatic tracking of a GPS flight plan. It is also used to “GOTO” a waypoint directly as selected in the GPS.

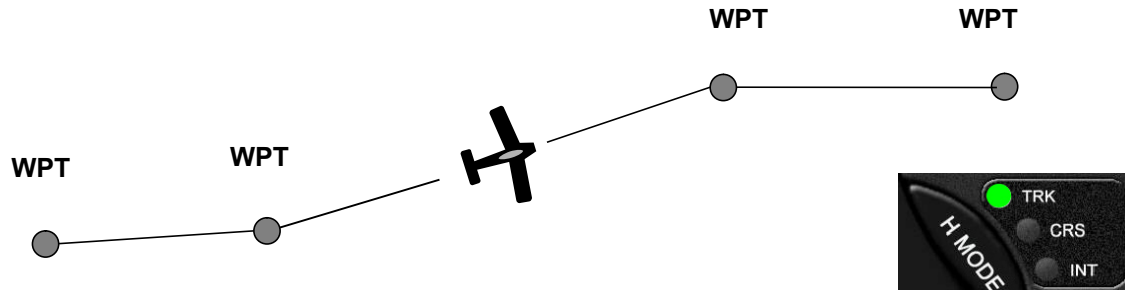

Course Mode (CRS)

The course mode (**CRS**) allows tracking a pilot selected course in lieu of a GPS route or GOTO waypoint. The **CRS** mode uses the GPS to provide heading information for the aircraft's ground track. This mode is useful for avoiding restricted airspace, weather, oncoming air traffic and following ATC directed vectors.

In this mode, the rotary encoder switch is used to change the commanded course.

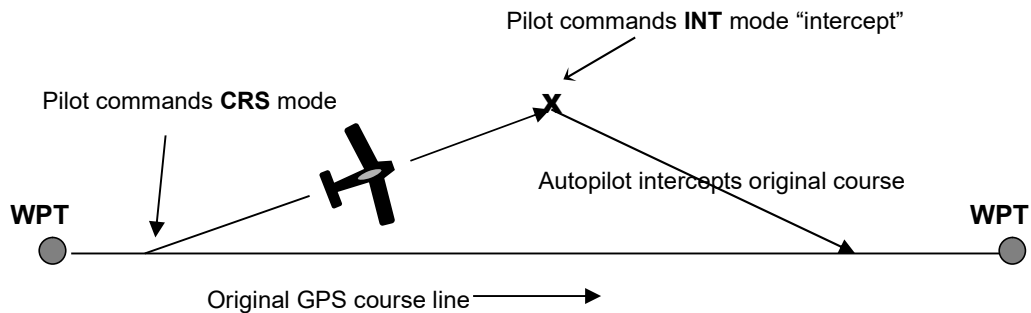

Hint: An alternative method of using the **CRS** mode is in conjunction with the Pilot Controlled Steering (PCS) mode of operation (see pages 30 & 31).

Intercept Mode (INT)

The intercept mode is used to intercept or regain the original flight plan track for some reason, such as when you have flown some distance from your intended flight plan and wish to return to it.

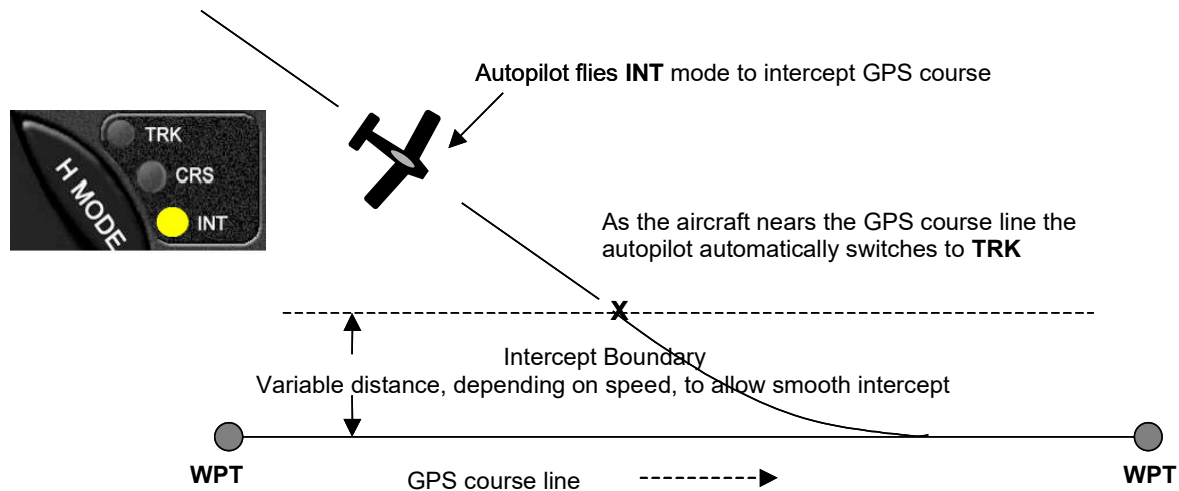

In both the **CRS** and **INT** mode, the ground track heading may be changed by rotating the encoder knob or using the **PCS** steering mode of operation.

- In the Course (CRS) mode, rotating the encoder clockwise causes a course change to the right. Counterclockwise rotation will cause a course change to the left. The course will change by 1 degree per "click" of the encoder, or, if rotated briskly, will change the course by several degrees during rotation
- In the Intercept (INT) mode, the intercept angle to the original track may also be changed by rotating the encoder. The intercept angle will change in the direction that the encoder is rotated (as above). The Pro Pilot will automatically switch from the **INT** mode to the **TRK** mode as it closes on the intercept boundary.

Chapter 2

Vertical Navigation Overview (VNAV)

The **V NAV** function of the Pro Pilot controls the pitch axis of the aircraft. It provides commands to the pitch servo that attaches to the elevator control system. The **V NAV** system uses a rate gyro, pressure sensors, airspeed sensors and accelerometers as primary references in controlling the pitch attitude of the aircraft. The **V NAV** system does not depend upon a GPS signal for its functions. For precision RNAV vertical descent guidance to a runway it can be controlled by inputs from an approach certified GPS receiver.

Operation

While the Pro Pilot also has several vertical functions, the basic mode is that of “**ALTITUDE HOLD.**” A manual climb to altitude desired and a single press of the **V NAV** button will engage the pitch servo and maintain that altitude.

Three vertical navigation modes allow the pilot to maintain altitude, climb/descent at a selected vertical rate (in feet per minute) and preselect a destination altitude. An additional pilot controlled steering capability allows the pilot to choose airspeed instead of vertical speed for the climb/descent by use of the autopilot disconnect/PCS button on the stick or yoke.

Basic V NAV Operation Modes

The capabilities of the **V NAV** system comprise three basic modes:

1. Altitude hold
2. Vertical climb and descent rates, and airspeed capture and control
3. Altitude pre-select, which can be used in conjunction with the vertical modes

Envelope protection in the form of minimum and maximum safe airspeed management modes are also included to prevent stalling and over-speeding the aircraft.

Altitude Hold

To operate the altitude hold, fly to the desired altitude and level the aircraft in trim. Press the **V NAV** button to engage the pitch servo and the aircraft will hold at that altitude. Press the **V MODE** button and then rotate the encoder knob for minor adjustments to accommodate barometer updates.

Manually fly the plane to the desired altitude and engage the Altitude hold

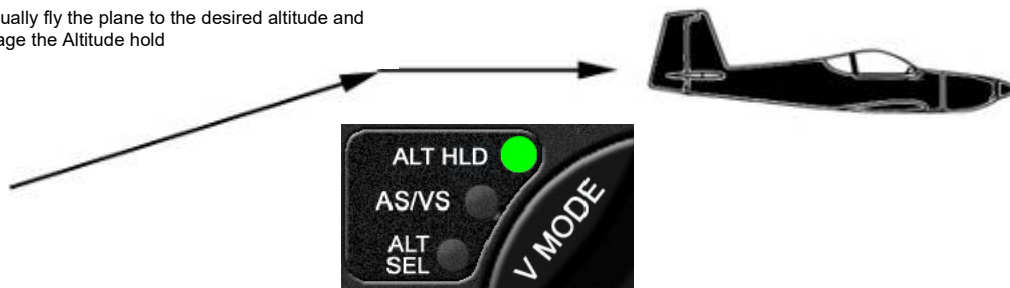

Vertical Climb/Descent

The Pro Pilot also allows the pilot to select a desired climb or descent rate (i.e. **VS** (vertical speed), in ft. per minute). Press the **V MODE** button again and:

Set the desired climb or descent rate by rotating the encoder knob. Press the encoder knob to initiate

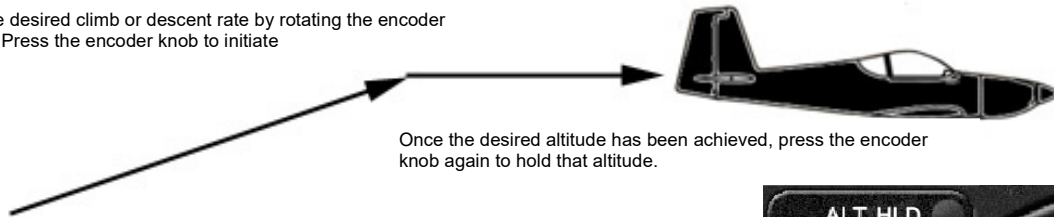

Airspeed Capture and Control (using PCS)

During climb and descent, the desired airspeed can be adjusted using the **PCS** (Pilot Command Steering) mode (see page 31). After the airspeed has been captured the airspeed can be increased by rotating the encoder clockwise, or decreased by rotating the encoder counterclockwise. This feature can be useful to ensure adequate cooling of the engine during climb.

Set the desired climb or descent airspeed by employing the PCS (Pilot command Steering) mode. Press/Hold the remote disconnect button and establish the climb/descent airspeed.

Set a desired climb or descent rate and enter a target altitude. Press the encoder knob to initiate

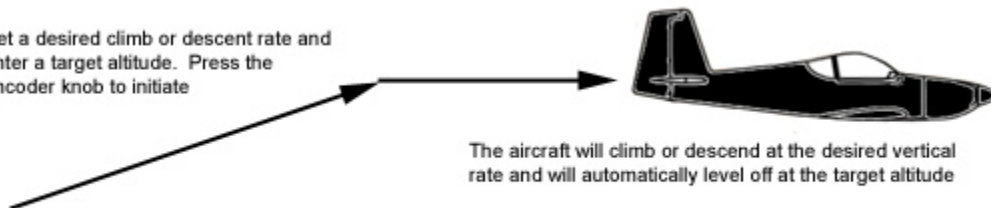

Altitude Pre-Select

The Pro Pilot adds the ability to climb or descend to a pre-selected destination altitude. Press **V MODE** to advance to Altitude Select (**ALT SEL**). Rotate the encoder knob to select destination altitude.

Set a desired climb or descent rate and enter a target altitude. Press the encoder knob to initiate

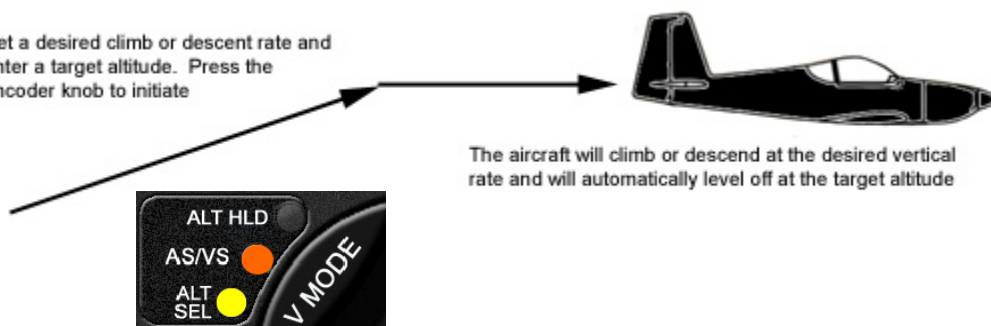

Chapter 3

Control and Display Overview

The control/display unit is designed to fit in a standard 3 1/8-inch instrument cutout in the instrument panel, or a stack mount that installs into the radio stack. The unit is powered from the airframe +12V DC or +24V DC systems.

Switch Function and Operation

ON/OFF Switch

The **ON/OFF** switch applies aircraft power to the Pro Pilot. In the **OFF** position, the Pro Pilot is disconnected from the aircraft control system. It is recommended that the Pro Pilot be turned on immediately after engine start. Upon power up, the display presents a logo and the current Pro Pilot firmware code version (or a customized screen) and sets several default conditions as follows:

Upon power up, the screen will display the un-calibrated field elevation (if the aircraft is on the ground) or un-calibrated altitude (if the aircraft is flying). The value is expressed in feet.

The pilot must adjust this value to agree with the primary aircraft altimeter, which has been previously adjusted to the reported barometer setting to calibrate the elevation/altitude.



ELEVATION SET
820

Once the Pro Pilot altimeter has been adjusted, pressing the encoder knob will enable the navigation screen.

Operation

Initially, with GPS data available, the **TRK** (Track) mode is selected and the **TRK** LED is illuminated. This mode is not fully operational until valid GPS data is available. When GPS is unavailable for seven seconds, or after initial power up, the display will default to a flashing "**NO GPS**" message.

NOTE: The **HMODE** LEDs will not illuminate if valid GPS data is not available.

Without GPS input, the autopilot will still function as a wing leveler and the rotary encoder can be used to initiate turns to the left or right or to correct airplane heading drift for straight ahead flight. Because the **V NAV** function does not rely upon GPS, the vertical navigation system will be unaffected.

Once GPS data is present and validated, full lateral navigation functionality is available and the **H MODE** LEDs will illuminate.

If no flight plan or "GOTO" waypoint has been selected in the GPS receiver, a "**NO FLTPLN**" message will appear in the upper right display field and the course mode (**CRS**) is automatically selected (**CRS** LED illuminated).

All servo power is initially off on power up and the Pro Pilot is disconnected from the aircraft control system.

H MODE and V MODE buttons

The **H MODE** switch controls the selection of the **TRK** (track), **CRS** (course) and **INT** (intercept) modes. With GPS data present, the default mode during power up is **TRK**.



Pressing the **H MODE** switch repeatedly advances the display screen from:

TRK ---> **CRS** ---> **INT** and then back to **TRK**.

The appropriate LED illuminates in each mode.

NOTE – The **INT** LED may not illuminate if the **XTK** is less than approximately 0.05 NM.



No **H MODE** LEDs will illuminate until valid GPS data is available.

At any time while in the **INT** mode, the pilot may transition to the **TRK** mode, or through **TRK** to **CRS** mode, by pressing the **H MODE** switch.



The **H NAV** button also provides the “**AUTOMATIC COURSE REVERSAL**” feature which does an automatic roll servo engagement and ground track reversal. Please see page 27 for operation instructions for this feature.

The **V MODE** switch controls the selection of the **ALT HLD** (altitude hold), **AS/VS** (airspeed/vertical speed), and **ALT SEL** (destination altitude set) modes.



Pressing the **V MODE** switch repeatedly advances the display screen from:

ALT HLD > **AS/VS** > **ALT SET** > **ALTITUDE (ELEVATION) SET**.

The appropriate LED illuminates to signify data has been changed or entered on that screen. The **ALT HLD** LED is illuminated when the altitude hold mode is active, or the **VS** mode is active and the vertical rate is set to zero. The **ALT HOLD** mode LED will flash to indicate that an executed fine altitude adjustment is in progress.

Roll (H NAV) & Pitch (V NAV) Servo Activation

The **H NAV** and **V NAV** pushbuttons activate the roll and pitch servos, respectively. When the **H** or **V** LED is unlighted, the respective servo is inactive and that autopilot function is disconnected from the control system. When the LEDs are illuminated, the Pro Pilot is engaged and providing control signals to the Pitch and Roll servos.

The roll servo is activated (or deactivated) by pressing the **H NAV** pushbutton momentarily.

The pitch servo is activated (or deactivated) by pressing the **V NAV** pushbutton momentarily.

The servos may be operated independently of each other.



Remote Disconnect Switch

Pressing the remote disconnect button momentarily will immediately disconnect both the pitch and roll servo, freeing the aircraft controls for manual operation. This same remote disconnect switch also provides an important additional functionality called Pilot Command Steering (**PCS**) which is used for both for horizontal and vertical navigation.

Rotary Encoder - Pushbutton Switch

The black knob in the center of the control head implements three important functional control mechanisms.

1. It can be rotated for inputting or changing selections or inputs
2. Pressing the knob activates a momentary switch
3. In a single operation it may be pushed in and rotated at the same time.

Each of these provides varying functions, depending upon which mode of operation has been selected with either the **H MODE** or **V MODE** pushbuttons. Pressing the **V MODE** button will allow the encoder to change parameters associated with the altitude control, while pressing the **H MODE** button will allow encoder adjustment of functions associated with horizontal navigation.

The encoder switch is used in conjunction with the **PREFERENCE** modes to change various settings. These are described in the setup menus (Chapter 10) of the manual.

The Display Arrow

An arrow is centered in the upper line of the display. The arrow indicates which functions (**H MODE** or **V MODE**) the rotary encoder (and its pushbutton) will control when it is operated.



- When the arrow points to the left, the encoder will control the **H MODE** functions.
- When the arrow points to the right, the encoder will control the **V MODE** functions.

The **H MODE** or **V MODE** button, when pressed, will change the arrow direction and transfer encoder control to the appropriate mode.

NOTE: When switching the display/encoder from **H MODE** to **V MODE** the initial button press will simply change the direction of the arrow and the right-side display parameters.

The encoder pushbutton switch performs a number of functions, depending which way the arrow is pointing. **It is important to note the direction of the arrow BEFORE initiating any encoder action to assure that the proper values are changed.**

H MODE Encoder Functions

- If the arrow is not pointing to the left, press the **H MODE** button



1 – Display Data Fields

The pushbutton of the encoder switch selects what data is presented on the upper right field of the display while displaying **H MODE** parameters. Rotating the encoder pushbutton advances the **lower right** line variable display field through the available field selections. The selections are described beginning on page 20.

Pressing and holding the encoder button down, then rotating it, selects and adjusts the track offset parameter (**TOP**) which will be displayed in the **upper right** variable display field (see function 3, below).

2 – Scan Mode

Pressing the encoder pushbutton switch rapidly two times in quick succession (double-click) will cause the variable field data in the right part of the lower line to “scan” (or scroll), providing a sequential display of the various GPS data elements being received.

The turn coordinator information is not provided in the “scan” mode; however, it is available in the upper right field (see Function 5 below).

Exit from the scan mode is accomplished by double-clicking the display button again. Whenever the **SCAN** mode is active a small dot will appear in the display in front of the lower right data field indicating the **SCAN** mode is active.

3 – Top Line Data Selection

To select the data that will be displayed in the right side of the upper display line, the user may momentarily press the encoder knob. A press and release cycle will advance the upper right display field to the next display parameter. (Do not rotate the encoder – press only!)

NOTE: The **TOP** field (track offset position) is selected and adjusted by pressing, then holding and rotating the encoder knob (in the **H MODE** only).

4 – Track Offset Position (TOP) Control

In the **TRK** mode, the rotary encoder is used to set a Track Offset Position (**TOP**). The **TOP** field is selected and adjusted by pressing, then holding and rotating the encoder knob (This is only possible while in the **H MODE** display with the arrow pointing to the left). The display will change in one-tenth mile increments to the left or right to a maximum of three miles from the centerline.

5 – Ground track Adjustment

In either the course (**CRS**) or the intercept (**INT**) modes the rotary encoder is used to select the commanded (**CMD**) ground track (**GTK**) that the autopilot is set to follow. Rotating the encoder changes the commanded ground track (**CMD**) in one-degree increments per “click” of the encoder. Rotating the encoder quickly changes the course in larger increments. Rotating the encoder counterclockwise alters the commanded course to the left, while rotating the encoder clockwise alters commanded course to the right. (This is comparable to a traditional “Heading Bug” function).

6 – Drift Correction (NO GPS mode only)

Rotating the encoder to the right or left allows the pilot to adjust roll TRIM either right or left by one trim count. *This is a very fine trim adjustment.* The lower display fields will show an analog bar graph of the trim correction being input while the switch is activated and for about two seconds after the encoder action is stopped. At that time the lower display fields revert back to the rate of turn function

If the GPS data to the Pro Pilot is unavailable, as indicated by a **NO GPS** warning, the encoder knob switch provides a method to turn the airplane to a new heading or stabilize the aircraft in a straight and level attitude. The pilot should monitor the turn progress by observing the aircraft directional gyro or compass.

7 – Entering “PREFERENCES MENU”

Pressing and holding the encoder pushbutton for more than 3 seconds causes entry into the **PREFERENCES MENU** for adjusting the parameters and features for both the horizontal and vertical portions of the Pro Pilot. This feature is explained in Chapter 10.

V MODE Encoder Functions

- If the arrow is not pointing to the right, press the **V MODE** button



1 – Activate Climb or Descent

Press the **V MODE** button repeatedly to display the **VS SET** screen. Enter a climb or descent rate by rotating the encoder. Pressing the encoder will initiate the function if the servo is ON. In this case the upper right display field will read **VS ACT** (vertical speed is active). If the ENCODER is pressed and the servo is not ON, the display will read **VS SUSP** (vertical speed suspend). In this case the vertical speed will automatically become active when the servo is turned ON. If the ENCODER is not pressed, but a vertical speed is entered, the screen will show **VS ARM**. In this case if the servo is turned on the system will remain in altitude hold until the encoder is pressed to activate the VS mode.

NOTE: The servo must be engaged by pressing the **V NAV** button for climb or descent. When the VS mode is active the VS LED will be illuminated.

NOTE: In the following paragraphs the function can either be ELEVATION (ELEV) or ALTITUDE (ALT). Selection of either elevation or altitude is keyed on whether the aircraft is in flight. If not in flight elevation will be displayed and the ENCODER will adjust the parameters in 5 ft increments. If in flight the fields will refer to altitude and the adjustment is in 20 ft increments

2 – Activate Climb or Descent to a Pre-Selected Altitude

Press the **V MODE** button repeatedly to display the **ALT SET** screen. Enter a destination altitude by rotating the encoder. Rotating the encoder will increase or decrease the selected altitude in hundreds of feet. Pressing and rotating the encoder will change the display in thousands of feet. Pressing the encoder momentarily thereafter will first present the **ALTITUDE (ELEVATION) SET** screen to allow correction of current altitude. A second press of the encoder (or waiting for 5 seconds to timeout) will initiate the function.

NOTE: The climb/descent rate will be at the vertical speed selected on the **VS SET** screen or, if none was entered, the system will use the default vertical rate that was previously entered in the **PREFERENCES** menu.

3 – Altitude Control Functions

When the Altitude Hold is engaged, the encoder knob is used to make fine adjustments to the altitude. It is also employed to set a desired climb/descent rate when on the **VS SET** screen, and it is used to select a destination altitude when it is on the **ALT/ELEV SET** screen.

4 – Setting the Altitude or Elevation

The encoder is used to adjust the autopilot internal altimeter when required.

Chapter 4

Preflight Power Up

This section discusses what must be accomplished when “powering up” the Pro Pilot, items to be checked and adjusted, and a flight example

On power up the Pro Pilot will briefly display the logo screen. This will be followed by a screen requesting verification of the current field elevation or altitude.

If the GPS is not yet powered up, after about 7 seconds the display will show the **NO GPS** message.

Note: The **TRK** LED is illuminated after the GPS signal is acquired and the **H NAV** servo is not activated (“**H**” **LED** is not illuminated). The aircraft roll control (ailerons) should be free and clear indicating the servo is disconnected from the control system.

The pilot now applies power to the GPS unit that is connected to the Pro Pilot and programs the GPS flight plan. On GPS power up, the display on the Pro Pilot may show navigation data momentarily on the display, as some GPS receivers will send sporadic GPS data. Typically, the **NO GPS** message will return as this data transfer ceases.

A preflight check on the Pro Pilot at this point would be to engage the servos by pressing the **H NAV** and **VNAV** pushbuttons momentarily and noting that the “**H**” LED and **V** LEDs illuminate. The servo is now controlling the ailerons and elevator. Using the control stick or yoke, the pilot should intentionally force the controls to their extreme positions to verify that the slip clutch on the servos will allow the pilot to continue to fly the airplane in the event the servo malfunctions.

If this check is satisfactory the **H NAV** and **V NAV** button should be pressed again to disconnect the autopilot from the controls. Verify that the LEDs are not illuminated and the servos are not engaged for takeoff.



Important: If all of the above actions cannot be properly achieved, turn the Pro Pilot off and do not attempt to engage the autopilot in flight. If there is any indication of a control system problem do not fly the airplane until it has been corrected.

When the GPS receiver attains satellite acquisition and lock, the Pro Pilot will display the power up default screen previously illustrated.



Some GPS receivers, even though they have obtained satellite lock, do not put out valid NMEA or AVLINK data until a flight plan or “GO TO” waypoint is entered or a preset groundspeed is attained (usually 2 to 5 knots). In this case either the “**NO GPS**” message or the “**NO FPLAN**” message will be displayed.

Some GPS receivers’ output data will provide ground track and groundspeed information to the Pro Pilot after satellite lock, even before a flight plan is entered. The Pro Pilot will detect this and provide the pilot with a modified **CRS** mode capability and display **NO FPLAN** in the upper right display field.

In this mode, manual transition to the **TRK** or **INT** mode is inhibited and **NO FPLAN** is displayed on the screen. In the **NO FPLAN** mode the pilot may use the autopilot **CRS** mode to fly a selected ground track. Once a flight plan has been entered the **TRK** mode is automatically selected.

The flight plan is now entered and activated in the host GPS unit. As the first “**TO**” waypoint becomes active the Pro Pilot will display the parameters associated with navigation to that waypoint. A check should be made to verify agreement between the data displayed on the Pro Pilot and the host GPS system.

Chapter 5

Information Fields

Horizontal Navigation (H NAV)

Pilot information for navigation is provided on a high contrast, bright Organic LED (OLED). Several fields on this display are multiplexed (i.e. they use the same display space to present different information). This allows the pilot to view all navigation parameters including digital rate of turn information. This section will explain in detail the horizontal navigational features and display screens available.

Power up Display

When the Pro Pilot is powered on a logo display is present showing the firmware revision operating in the unit. (This can be field programmed to present a personalized screen at power on).

Initial Logo Screen



The initial factory logo screen shows the product information including the firmware revision level and unit serial number in the extreme right part of the display (represented by the X's).

ELEVATION SET Screen



When the Logo screen expires after a few seconds, the **ALTITUDE (ELEVATION) SET** screen will be seen.

No functions will be available until the altitude (elevation) value is set and the encoder is pressed. The value should be set to agree with the primary aircraft altimeter, which has been corrected for current reported barometric pressure. The value may be changed in either five-foot (**ELEVATION**) while on the ground or twenty foot (**ALTITUDE**) increments while in flight.

If GPS signals are present the display will switch automatically to the navigation display. If no GPS signals are present the screen will change to show that **NO GPS** is being received on the interface.

NO GPS Screen



The "**NO GPS**" screen will display on power up if no GPS signal is present or if the GPS signal is lost for a period exceeding seven seconds.

In all cases the navigation display will return to normal automatically when the GPS signals are reacquired.

Note: There may be a delay of up to seven seconds in restoring the display after a GPS signal becomes active on the interface.

In the event the GPS signal is lost during normal area navigation, the "**NO GPS**" screen will be shown and the Pro Pilot will automatically go into the wing leveler mode and follow a "straight and level" course. In this mode, manual corrections to the dead reckoning track (or trimming the airplane for straight and level flight) can be made using encoder knob.

No **H MODE** LEDs will be illuminated until valid GPS data is available.

Normal Power Up Display, GPS Active

On power up, once the (**ELEVATION**) **SET** has been performed, the Pro Pilot defaults to the **H MODE** display and the **TRK** mode of operation when valid GPS data is available.

The image shows the Pro Pilot display with a good GPS signal present, and flight plan entered. Note that the “H” (H NAV) LED is illuminated.



This indicates that the roll servo has been activated by pressing the **H NAV** button and the Pro Pilot is providing horizontal navigation, having taken control of the roll axis of the aircraft.

To view and control horizontal functions at any time it is necessary to press the **H MODE** button one time to transfer encoder control to the **H NAV** functions. If the arrow is already pointing to the **H NAV** functions the first **H MODE** press is not necessary. The mid upper arrow will point to the left. No navigational changes will occur.

Track Display Information

Bearing To Waypoint Field (BTW)

The bearing to waypoint (**BTW**) field is located on the left side of the upper line as illustrated. This field is updated whenever the GPS data to the Pro Pilot is refreshed, normally once every one or two seconds, depending on the GPS interface data rate. (A GPS with NMEA data output generally updates once every one or two seconds, while an Aviation Data Link updates once every second). **BTW** is the exact magnetic bearing from the current aircraft position to the next GPS route waypoint.

Note: The line directly below the **BTW** data contains the current track (**GTK**) information (if these two numbers are identical, the aircraft is tracking directly to the destination waypoint regardless of the actual magnetic heading of the aircraft).

Ground track Field (GTK)



The ground track (**GTK**) field is located on the line directly below the “Bearing to Waypoint” (**BTW**). The **GTK** field is the current track over the earth based on the GPS data.

Variable Field, Top Line

The right side of the upper line of the display may be changed to present any data derived from the GPS available in the lower line right field or an electronic rate of turn display. The factory default display is to present the information shown, but the user may wish to otherwise configure this segment. The top line variable field may be changed by repeatedly pressing the encoder knob while in the Track (**TRK**) mode. Rotating the encoder will change the variable field in the bottom line. “Double clicking” the encoder knob will cause the bottom line variable field to continually sequence through all available information. “Double clicking” again will exit the scan mode.

Cross Track Error Field (XTK)



Cross Track Error Field (**XTK**) provides a distance measurement in miles, tenths and hundredths of how far the aircraft is positioned either right or left of the desired track (**DTK**). The maximum value in this field is 9.99 miles.

A positioning symbol, immediately preceding the numerical data, indicates the “fly to” direction required to null this error.

- If this symbol has its apex to the left (<), the autopilot will fly to the left to eliminate the error.
- If the symbol has its apex the right (>) the autopilot will fly to the right to eliminate the error.



Here the aircraft is just .02 miles to the right of the desired track, so the autopilot will fly to the left to resume correct DTK.

Other Available Fields on the Lower Line

The bottom display line, extreme right field is another variable field used to display other tracking data of interest to the pilot. The possible data fields displayed are:

- **GS** Groundspeed, closure speed to the destination waypoint
- **ETE** Estimated time en route, in hours and minutes format
- **ETe** Estimated time en route, in minutes and seconds format
- **RNG** Distance to the current "TO" waypoint
- **(WPT)** "TO" waypoint identifier *
- **(TC)** Digital graphic turn coordinator display *
- **DIS?** Distance to the waypoint in excess of 999 miles
- **TRN?** Destination closing velocity indicates abnormal data
- **SPD?** Speed data in excess of 999 kts
- **TOP** Track Offset Position indicator
- **VS** Vertical Speed mode indicator**
- **AH** Altitude Hold mode indicator**

* No associated label field displayed

** Shown if the VNAV servo is on



Each field above except the **DIS?** **TRN?** and **SPD?** fields is selected by pressing the encoder pushbutton momentarily. The **DIS?** **TRN?** and **SPD?** fields are automatically displayed to indicate GPS data anomalies.

The **ETE** or **Ete** label format is selected automatically by the autopilot. The **TOP** field will not be displayed if the **TOP** value is 0.00 (no offset).

Groundspeed (GS)



The **GS** (groundspeed) field indicates the aircraft speed over the ground in knots as provided by the host GPS system. This field has a maximum value of 999 nautical miles per hour.

Estimated Time En Route, HH:MM (ETE)



The **ETE** (estimated time en route) field shows the time to the current waypoint based on the *closing velocity* (NMEA link only) to the waypoint (which may be different from the groundspeed **GS/distance** calculation discussed above).

If the last "E" in the **ETE** label is in upper case the display format is **HH:MM**, hours and minutes. This is switched automatically between **HH:MM** and **MM:SS** (minutes and seconds) as **ETe** depending on the results of **RNG/GS** (range/closing velocity) calculation.

Estimated Time En Route, MM: SS (ETe)



This field is identical to the **ETE** field except the format is **MM:SS** (minutes: seconds). This format is automatically displayed when the **RNG/GS** calculation indicates the next waypoint is less than 60 minutes away.

Range to a Waypoint (RNG)

```
BTW 025 ◀ XTK<0.02
GTK 025   RNG 121
```

This field contains the distance remaining to the current “TO” waypoint with the least significant digit being in tenths of a mile. If the distance is over 100 miles the least significant digit is in units of nautical miles (*GPS NMEA serial data output is always in nautical miles, even though the GPS screen may be set to statute miles*). This field is limited to a maximum value of 999 miles.

Waypoint

```
BTW 025 ◀ XTK<0.02
GTK 025   KDEN
```

The waypoint identifier currently programmed as the “TO” waypoint is presented in this field. Up to six alphanumeric characters are available for this data field, allowing for intersection and user waypoint identifications. This field will flash at a 2 pulses per second (PPS) rate for approximately 10 seconds when past the last waypoint in the route or past the last GOTO waypoint or if the aircraft is being flown 90 or more degrees away from the waypoint.

Digital Rate of Turn Display

```
GTK 235  XTK>0.01
[->-----> ■■■■ ←-]
```

A digital graphic representing the current yaw rate is presented to the pilot when this field is selected. The limit on this rate is approximately ± 4.5 degrees per second full scale.

On the turn rate display the 3 deg/sec rate is denoted by the tip of the marker presented in the display line. The display shows a standard rate turn to the right.

Automatic Field Scan Mode

If the encoder knob is momentarily pressed two times in quick succession (double-clicked) the variable field will enter or exit the “Scan Mode.” In this mode the data displayed is sequenced in the display at a 2.5 second rate. Additionally, it will also show the status of the altitude control functions when they are engaged.

This can be useful for sequentially monitoring all of the parameters put out by the GPS without having to select each parameter manually.

GPS Data Anomalies

DIS?

```
BTW 025 ◀ XTK<0.02
GTK 025   DIS?
```

DIS? is displayed in this field whenever the maximum distance in the GPS data stream is greater than 999 miles. Tracking functions are not affected by this condition.

TRN?

```
BTW 025 ◀ XTK<0.02
GTK 025   TRN?
```

The **TRN?** warning is displayed in this field when the Pro Pilot detects a negative closing velocity (going away from the “TO” waypoint).

This usually occurs when a waypoint greater than ± 90 degrees from the current waypoint is selected. No pilot action is required.

SPD?



BTW 025 ◀XTK<0.02
GTK 025 SPD?

The **SPD?** warning field is presented to the pilot when the parameters in the GPS data stream indicate a condition that results in an overflow of the **ETE** computation.

Under normal operation, these conditions should not exist; however, momentary corruption of the GPS data during signal acquisition or waypoint transitioning can cause these to appear. No pilot action is required.



Tracking functions are disabled until the condition is cleared automatically, usually on the next GPS update. Wing leveling remains in operation.

Chapter 6

Horizontal Operation

Track Mode (TRK)



The track mode (**TRK**) is used to track a GPS flight plan or fly directly to a “GOTO” waypoint. The autopilot uses the data stream from the GPS to determine the direction of flight. This mode requires a valid GPS signal to provide position information. If no GPS signal is present, this function will not be available.

- If a flight plan has been entered into the GPS, the autopilot will fly the desired track (**DTK**) to each point in the flight plan in sequence. In each segment it will show the Bearing to Waypoint (**BTW**)
- If a “GOTO” waypoint has been selected, the autopilot will fly directly to the waypoint.

To use the **TRK** mode, press the **H MODE** button to light the **TRK** LED. Press the **H NAV** button. The autopilot will engage and fly the plane directly to the waypoint or the flight plan **DTK**. If the plane is some distance from the course line, the pilot may use the intercept mode (**INT**) to automatically get back to the flight plan **DTK**.

This mode requires a valid GPS signal to provide position information. If no GPS signal is present, this function will not be available.

Tracking a Course (CRS)

The course mode (**CRS**) may be compared to flying with a heading bug in a traditional system, keeping in mind that you are selecting a course-over-the-ground (i.e., ground track, **GTK**) and not a magnetic heading. Initially when entering this mode, the course and track will be identical. If the pilot wishes to change the track of the plane, rotating the encoder knob will change the commanded course (like changing a heading bug). The autopilot will then change course until the **CMD** and **GTK** are once again identical.

Example: If given a heading to fly by ATC, press the **H MODE** button to light the **CRS** LED, rotate the encoder until the desired commanded ground track (**CMD**) is shown and press the **H NAV** button. The autopilot will engage and smoothly turn the airplane to the desired course.

Using Course Mode

Assuming the track mode (**TRK**) is currently selected, press the **H MODE** pushbutton to change the **H MODE** LED and display to the course mode course mode fields on the left side of the display.

When switching to the **CRS** mode the **BTW** label on the left side of the top line changes to **CMD**.

The three numeric characters following **CMD** represent the pilot commanded ground track. The **CMD** display field will show the current ground track (heading) the plane was traveling when the mode is entered.

The Pro Pilot will turn the plane to keep the ground track (**GTK**) and the commanded course (**CMD**) the same value.

Example: If the current ground track is 010 degrees when the **CRS** mode is selected, the commanded course (**CMD**) will be initialized to 010 degrees.

- If **H NAV** servo is activated while in the **CRS** mode, the current ground track is automatically entered as the commanded ground track (**CMD**).
- If the servo is OFF just select the **CRS** mode. Then, push the **HNAV** button (turning on the servo). This will cause the current course to be selected and the aircraft will continue straight ahead under GPS control.

The **GTK** field below the **CMD** field indicates the actual across-the-ground track (**GTK**) from the GPS.

While in the **CRS** mode, rotating the encoder knob allows the pilot to adjust the commanded course in one degree increments either right or left of its current value. Rotating the encoder more quickly changes the course in larger increments. After changing the **CMD** field with the encoder the plane will turn left or right until the **CMD** and **GTK** fields are once more the same.

The distance right or left of the desired track (**DTK**) is indicated in the **XTK** field in the top right display field (if selected by pressing the ENCODER) and is preceded by a left or right pointing apex (< or >), which shows which direction the airplane needs to fly to get back on the original **DTK** set by a flight plan or “GOTO” waypoint.

The pilot may exit the **CRS** mode by pressing the **H MODE** button until the desired mode (**INT** or **TRK**) is selected.

Note: If the **XTK** error is inside the intercept boundary line, the autopilot will sequence directly from **CRS** to **TRK** (bypassing the **INT** mode) when the mode button is momentarily pressed.

The **PCS** (Pilot Command Steering) mode provides an alternate mode of entry to the **CRS** mode and is described on page 31.

Intercept a Course (INT)

The intercept mode (**INT**) is designed to bring the aircraft back onto the **DTK** after being vectored around by ATC or when avoiding weather or flying around airspace restrictions. The intercept mode is useful to bring the plane back to the original flight plan **DTK** at a specific angle instead of using the GOTO feature to take you to the next waypoint (e.g. “resume normal navigation”). While in the **INT** mode the pilot is also able to adjust the commanded intercept angle as desired.

Intercept Operation

The intercept mode is activated by pressing the **H MODE** switch (to sequence from the **TRK** or the **CRS** mode) until the **INT** LED is illuminated.

NOTE: The **INT** mode cannot be entered if the **XTK** error is less than the computed intercept distance (**IDS**) from the desired track line (usually about ½ mile depending upon speed). This variable distance is computed as a function of the intercept angle and groundspeed. The automatic switch from the **INT** to **TRK** mode occurs at this distance to allow a smooth intercept. If the **XTK** is greater than the computed distance, then the **INT** mode can be entered.

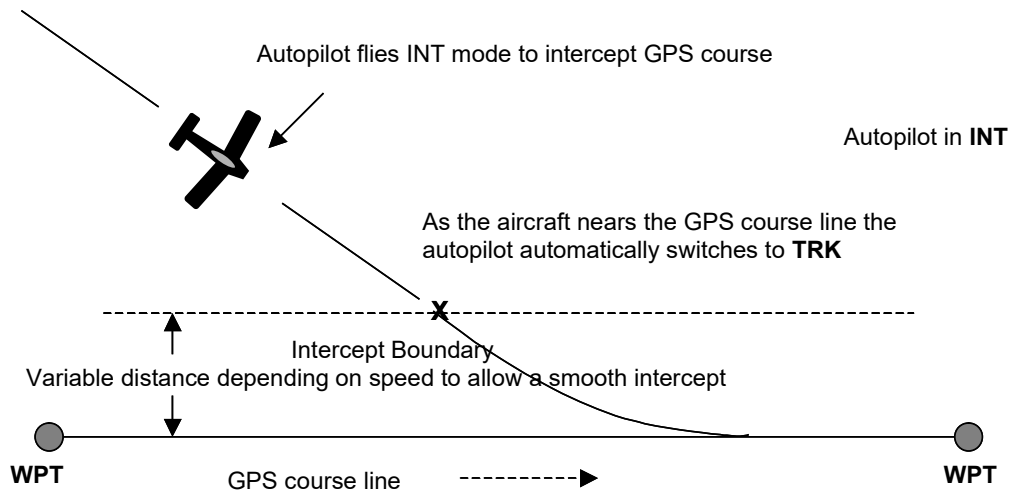

The automatic transition from the **INT** mode to the **TRK** mode is a function of the **XTK** (crosstrack error) magnitude, which is an index of the difference between the original course line and the position offset from the course line.

The **INT** mode automatically establishes an approximate 25-degree intercept angle (factory default setting) toward the flight plan or GO TO desired track (**DTK**). The commanded intercept course can be adjusted in the same manner as in the **CRS** mode using the rotary encoder switch or the pilot-controlled steering (**PCS**) mode. The **INT** mode is automatically canceled and the **TRK** mode is entered when the aircraft crosses the intercept boundary line.



The unit will automatically sequence from **INT** to **TRK** if the track error magnitude is below approximately 0.5 miles (intercept distance increases with speed). The precise switching distance is displayed as **IDS** (intercept distance) in the upper right display field when the **INT** mode is selected. The **INT** function is not available if the crosstrack error is below this variable limit or the aircraft is on the ground (low groundspeed).

Selecting a Track Offset Position (TOP)

With the advent of highly accurate GPS navigation and coupled autopilots, aircraft are tracking more and more closely to the airway centerlines on designated airways (the Pro Pilot can easily hold the course centerline within 50 to 100 feet in smooth air). This creates the real possibility of overtaking or head-on encounters with other aircraft that are also tracking the airway centerline, especially during climb and descent when normal altitude separation is not in effect.

To help avoid such encounters, the Pro Pilot incorporates a safety feature heretofore found only in high end navigation systems – Track Offset Position (**TOP**).

Track Offset Position allows the pilot to fly a ground track which is offset by up to three miles from the centerline between the waypoints (desired track, or **DTK**).

To **enable** the **TOP** function, do the following:

In the **TRK** mode (only) **press** and **rotate** the **ROTARY ENCODER** switch counterclockwise or clockwise to select the offset distance to track, (either to the left or the right of



the **DTK** centerline). The arrow indicator denotes the direction of the offset and the numeric field indicates the offset selected (measured in miles and tenths of a mile). Changes to the offset may be made in 1/10th mile increments up to 3 miles.

To **disable** the **TOP** function, do one of the following:

In the **TRK** mode (only) **press and rotate** the **ROTARY ENCODER** switch counterclockwise or clockwise to change the offset distance to 0.0, or by changing modes, or by simply cycling power to the Pro Pilot using the **POWER** switch.

When activated, the arrow on the **XTK** changes from an outline arrow (>) to a fully filled arrow (▶). The **TOP** setting will also be flashed in the upper right display field periodically. These indicators alert you that the **TOP** feature is active.

NOTE: It is important to remember that the final waypoint will also be offset unless the TOP offset is set to "0.0" prior to arrival at the waypoint.

Initiating the Recover Mode

Should a pilot inadvertently enter a cloud and become obscured and disoriented they may invoke the "Recover Mode" by pressing a **RECOVER** button on the instrument panel. This will immediately cause the aircraft to seek a wings-level attitude and the autopilot will enter the **ALT HLD** (altitude hold) mode.

NOTE: It is important to realize that the autopilot must be powered on for proper operation. This mode will work in the absence of the GPS signal as long as the autopilot was active with either the GPS or the wing leveling mode prior to engaging the **RECOVER** mode

The following scenario assumes that the pilot is hand flying, the GPS is on and locked to the satellites. The aircraft and the servos are not engaged.

When the **RECOVER** button is pressed, the autopilot will "snapshot" the current direction the nose of the aircraft is pointing and turn on the servos. It will first roll the aircraft toward a wings level attitude. (If the aircraft was in a steep spiral, pulling on the elevator would only tighten the spiral and aggravate the situation). Once a reasonable bank attitude is achieved it enables the altitude hold functions to recover the aircraft to the altitude it was at when the button was pushed. It will also return to the course being flown when the button was pushed.

The autopilot will now be flying in the CRS (Course) mode and holding altitude. Once the pilot regains orientation, he/she may rotate the encoder to change the course if so desired.

Initiating an Automatic Course Reversal

In an effort to increase safety and save lives, this mode may be initiated as an emergency aid to the VFR pilot who inadvertently enters IMC conditions and needs to execute an immediate course reversal.

NOTE: It is important to realize that the autopilot must be powered on and receiving a good GPS data signal for proper operation.

You may be tracking a flight plan but a sudden IMC encounter may not leave you with an opportunity to reprogram your GPS to reverse the flight plan. **This procedure does not require you to adjust your GPS receiver.**

If you are manually flying your aircraft, this procedure will also work because *the servo does not have to be engaged* to initiate this emergency procedure so long as the power is on and the GPS has lock on the satellite data.



The procedure is simple and straightforward. Press and hold the **H NAV** or **V NAV** button for three seconds. The Pilot Pro will execute a 180 deg turn. ***That's all you need to do!***

After three seconds the following will occur:

- The servo will be energized (if off) and the wing leveler function will engage.
- The upper right display line will read “**TRN 180**”
- The lower right display line will be forced to the rate of turn - turn coordinator display
- If the **H NAV** button was held, a 180 degree left course reversal will be executed.
- If the **V NAV** button was held, a 180 degree right course reversal will be executed
- In each case, the **V NAV** servo will engage in the **ALT HLD** mode.



The display screen will change as shown. The reversed ground track will remain in effect until canceled by selecting another mode (or using the **PCS** mode). A right 180 turn is indicated by the

arrow preceding the “180”.

Variable Display Field – Top Line

The right side of the upper line (normally the **XTK** field) may be reconfigured to allow any of the parameters displayed on the bottom variable field to be selected for display. The parameter to be displayed is selected by momentarily pressing the **ENCODER** switch. To change the displayed parameter, do the following:

1. Momentarily press the **ENCODER** knob
2. Repeat until the desired parameter is displayed

Corrupted GPS Data Stream

On occasion, when a new waypoint is manually selected on the GPS, the data in the GPS input stream might be corrupted momentarily. The Pro Pilot is programmed to detect this and will set the display fields to “----”(dashed lines) or may enter the **NO FPLAN** mode when the condition is detected. This is usually a condition that clears after another GPS sample or two is transmitted to the Pro Pilot. **No pilot action is required.** Normal **TRK** mode tracking computations are inhibited until the GPS data integrity is restored.

Chapter 7

Horizontal Flight Examples

Flying to a Course line (DTK) or GOTO Waypoint

After takeoff, and at a safe altitude, enter a flight plan in your GPS and press the **H NAV** pushbutton momentarily. Note that the “**H**” LED is now on and the autopilot has control of the aircraft.

Note: As a safety feature, during the takeoff roll, the Pro Pilot checks the status of the servos. At 25 knots GPS groundspeed, or 40 knots indicated airspeed (if GPS is not available) it will automatically disconnect the servos, allowing free movement of the control surfaces. This is a backup feature only and should not be relied upon to replace a necessary preflight checklist item.

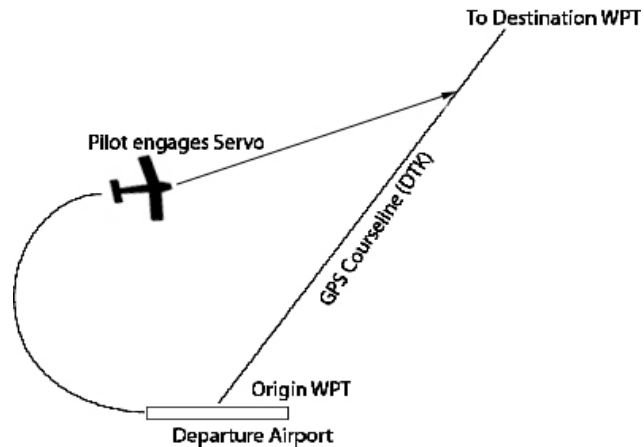

One of the design features of the Pro Pilot is its ability to identify the desired track line (**DTK**) and fly to it regardless of the direction the airplane is heading when the autopilot is engaged. In an extreme example, the plane might be flying 180 degrees away from the GPS routing and the Pro Pilot will bring the aircraft around smoothly to the proper ground track and pick up the programmed **DTK** (zeroing the cross track error). In the example shown above, the pilot engages the servo after takeoff and climb to safe altitude. The Pro Pilot then intercepts and flies the desired track (**DTK**) to the first waypoint.

Note: It must be remembered that the flight plan establishes a desired track between two points - in this case the departure WPT and the first destination WPT. Since the location of the plane is not on the desired track, when the **TRK** mode is selected and the servo activated the autopilot will **first** fly to the desired track and then proceed along the **DTK** to the WPT.

As an alternate, to proceed directly to the WPT from your present position, the pilot would utilize the “Direct To” feature of the GPS receiver. The Pro Pilot would then track directly to the desired WPT.

During the flight on this leg some other navigation parameters are available for review, such as estimated time to the waypoint (**ETE** or **ETe**). Turning the knob of the **ENCODER** presents this data. Rotating the encoder knob again will show **RNG** (distance) to this waypoint. The knob is rotated until **GS** or **WPT** is back on the display, since this field is probably referred to most often in flight, or the pilot may engage the scan mode to see all parameters (see page 20). Additionally, the upper right display field can be programmed to display any of the GPS derived data as described on page 20. An added feature of the **ENCODER** use is that if it is rotated counterclockwise, it will immediately return to the rate-of-turn display. This is handy to get back to a known point in the sequence, or to use the turn display if immediately needed in flight

Loss of GPS

With the GPS antenna placed where it can “view” all of the satellites available, it is unlikely that a loss of reliable GPS signal will occur. However, if the GPS



receiver is a handheld device without an external antenna (especially if it is being used in the cockpit of a metal airplane) it is possible to experience a temporary loss of GPS signals.

In such case, after approximately 7 seconds without signal the Pro Pilot displays the **NO GPS** message. Since the Pro Pilot is no longer able to provide the navigation function, the **ENCODER** can be used to control the aircraft turn rate, or to correct for gyro drift to affect a straight-ahead flight path

The Pro Pilot servo is still engaged so the aircraft is being controlled in the “wing leveler” mode (aircraft roll stabilization). Without the GPS signal, the Pro Pilot solid-state gyro lacks a precise external reference and after several minutes may begin a slow change in heading due to gyro drift. In order to change the heading slightly to stop the drift, the pilot needs to monitor the compass heading and rotate the **ENCODER** either left or right to maintain the desired heading.

Course Mode Example

As the flight progresses the destination, Class B airspace is entered after getting the appropriate clearances.

Flying along on the pre-selected 010-degree **CRS**, Approach Control requests “Turn right 30 degrees for clearance from other traffic.”



This turn can be accomplished in one of two ways:

1. The **CRS** mode is selected by pressing the **H MODE** pushbutton momentarily. The following changes in the display are noted:
 - The **TRK** LED extinguishes, the **CRS** LED is illuminated
 - The **BTW** field changes to **CMD**
 - The **CMD** field changes to **<010**
 - The **CMD** and **GTK** fields are, for the moment, identical (010)

desired **CRS** is 040 degrees so the **ENCODER** is turned clockwise until 040 is displayed as the **CRS** value. The Pro Pilot turns the airplane until both the commanded track (**CMD**) and the ground track (**GTK**) are the same (**040**).

2. **PCS** mode (see page 31) is invoked by pressing and holding the **Remote Servo Disconnect/PCS** switch and manually flying the aircraft to the desired ground track, releasing the switch when the desired ground track is achieved.

The illustration on the right now shows that the aircraft has turned right and is presently 1.08 miles to the right of the **DTK**. A few minutes later, Approach advises to “resume normal navigation.”

There are two ways to use the autopilot to return to the original desired track (**DTK**).



1. The intercept mode (**INT**) may be used to return to the original preprogrammed route via a default 25-degree intercept angle, and a subsequent adjustment to that preselected angle, or-
2. Going directly back to the **TRK** mode causes the aircraft to more gradually curve back to the **DTK**.

Alternatively, the pilot may choose to enter a “Direct” command into the GPS system, thus proceeding directly to the next waypoint rather than intercepting the original desired track (**DTK**).

NOTE: If a “direct to” GOTO waypoint is selected the autopilot will automatically switch to the **TRK** mode since the cross track error will be zero.

Intercept Mode Example

Assume that, while in the **CRS** mode, the aircraft flew 5.1 miles right of the desired track (**DTK**), as shown on the display’s cross track (**XTK**) field. Also assume that the computed intercept boundary switch point is 1.0 miles. The intercept (**INT**) mode is selected by pressing the **H MODE** switch. The **CRS** LED extinguishes, and the **INT** LED illuminates. The following changes are present on the display:



The upper right display field changes to intercept distance (**IDS**) and the value in the **IDS** field is 4.1 miles. This display indicates that you are in the intercept

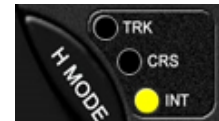

mode, correcting to the left and you are 4.1 miles from the switch point back to the **TRK** mode.

The **CMD** label changes to **INT**. The Pro Pilot selects a 25-degree intercept angle automatically.

The aircraft now turns left to the ground track commanded in the **INT** field. After a short interval the **GTK** and **INT** values are approximately the same, indicating a steady intercept track. The **IDS** value steadily decreases toward zero.

If it is desired to change the default intercept angle the pilot may engage the **PCS MODE** by pressing and holding down the Remote Servo Disconnect switch on the stick (or yoke) and flying the aircraft manually to the desired intercept course at which time the switch is released. Releasing the switch locks the new ground track as the desired intercept angle.

The **ENCODER** may also be used to change the intercept angle (**INT** field) while in the **INT** mode. When adjusting the intercept angle care must be taken to ensure the selected angle will result in an intercept of the **DTK**.

Progressing toward the **DTK**, as the **IDS** value approaches 0.0 the Pro Pilot switches automatically from the **INT** mode to the **TRK** mode when the aircraft is 1.0 miles right of the **DTK**. The Pro Pilot now is turning the airplane back to the right slightly and the **XTK** is approaching 0.00. The Pro Pilot will now re-establish the airplane back on the **DTK** headed directly toward the programmed waypoint.

NOTE: While the pilot could have gone directly back to the **TRK** mode to get back on course, the **INT** mode provides a definite (and adjustable) intercept angle to accomplish the return to the course line. The **TRK** mode uses a different turn algorithm which may extend the time required to return to the course line.

Horizontal Use of Pilot Command Steering (PCS)

The Pro Pilot provides a convenient way for the pilot to control the ground track that the airplane flies. By pressing, and holding, the remote **Servo Disconnect/PCS** switch on the control stick, the pilot can manually turn the aircraft to the desired course. Upon releasing the button, the autopilot will track that course. The switch must be held down for a minimum of 3 seconds to engage this feature. Holding for

less than 3 seconds will cause the servo to disconnect and it will have to be re-engaged by pressing the **H NAV** and/or the **V NAV** button on the control/display unit.

When the remote button is pressed initially, the “H” LED will extinguish normally, and the servo will disconnect, giving the pilot full control of the aircraft. After the button is held down for 3 seconds or more, the “H” Servo LED will begin to flash, indicating that the servo will re-engage when the button is released. This allows the pilot to manually orient the aircraft to the desired course and re-engage the servo when the button is released.

If the autopilot is in the **TRK** mode when the **PCS** is initiated the **CRS** mode will automatically be selected when the **PCS** switch is released. If the **CRS** or **INT** modes are active when the **PCS** mode is initiated, the autopilot will remain in that same mode when the **PCS** switch is released.

When the **PCS** servo reconnect occurs the current **GTK** is snapshot as the commanded ground track (**TRK** or **CRS** entry) or intercept angle (**INT** entry).

NOTE: The PCS function also works with the altitude control portion of the Pro Pilot. This is discussed in detail later in this manual.

Chapter 8

Vertical Operation

Vertical Navigation (V NAV)



Generally speaking, except for warnings and alerts, the display screen will present the Vertical Navigation information on the righthand half of the display screen when the encoder has been assigned to the **VNAV** functions.

To view and control the vertical functions it is necessary to press the **V MODE** button one time to transfer encoder control to the **V NAV** functions.

Pressing the **V MODE** button once will dedicate the righthand half of the display to the **V NAV** functions (and the mid upper arrow will point to the right). No navigation changes will occur.

Altitude Hold (ALT HLD)

In the example shown the pilot has pushed the **V MODE** button one time to transfer encoder control to the **V NAV** functions (arrow points to the right).

Here, the “**V**” LED is illuminated, indicating that the pilot has pressed the **V NAV** button and the autopilot pitch servo is engaged and holding altitude. Additionally, the **ALT HLD** green LED will illuminate to show that the autopilot is in the Altitude Hold mode.



Rotating the encoder knob will then adjust the altitude up or down by about 5 feet per “click” on the encoder (Rotate clockwise to go up and rotate counterclockwise to go down).

The message “**ALT ADJ**” will then appear on the screen to indicate that a slow altitude change (approximately 100 ft/min) is underway. In addition, the **ALT HLD** green LED will flash while the altitude change is in progress. The “**UP/DN**” message will change to read either “**UP**” or “**DN**” depending upon which direction the knob was rotated.

Once the commanded altitude has been reached, the LED will stop flashing and the display will revert back to showing normal **ALT HLD** message.

NOTE: This function is used only for slight changes in altitude, such as adjusting for a change in barometric pressure on a cross country flight. After adjusting the primary aircraft altimeter, the Pro Pilot may be slightly off altitude.

If the required altitude correction is more than 30 or 40 feet, the pilot may simply rotate the encoder knob slowly a couple of times to initiate the gradual climb or descent and then, when the desired altitude is reached, press the encoder knob momentarily to cancel any further correction and once again hold the current altitude.



To restore the display to presenting the **H NAV** information press the **H MODE** button and the center arrow will reverse, indicating that the display and encoder are now devoted to **H NAV** functions.

However, the **ALT HLD** LED will remain illuminated to indicate that the **ALT HLD** is still active.

Setting Vertical Speed (SET VS)

The Pro Pilot has enhanced altitude control features that allow the aircraft to climb and descend under autopilot control. This provides several additional capabilities and safety features:

- A major safety feature of the Pro Pilot is its ability to prevent the system from stalling or over speeding the aircraft. To facilitate this, the control head contains an airspeed sensor, which must be connected to the aircraft pitot system.
- Vertical climbs and descents may be performed by setting the desired vertical rate via the encoder knob and pushbutton switch.
- Pilot Command Steering (**PCS**) allows the pilot to press the remote disconnect switch to fly the aircraft manually to establish a desired climb or descent rate and (when the remote disconnect button is released) the aircraft will hold that vertical rate.
- Alternatively, the pilot may choose— via the **PREFERENCES** setup menu – to have the **PCS** mode climb and descend on airspeed (instead of vertical speed). This airspeed mode (**AS**) will allow the ability to maintain a specific airspeed during climb or descent to help maintain proper engine temperature.

NOTE: In the **PCS** mode the vertical rate change must be at least 200 FPM or the Pro Pilot will enter **ALT HLD** upon releasing the **PCS** (remote disconnect) button. If the rate is greater than 200 fpm it will maintain the climb/descent (or airspeed) that it senses when the button is released.

For the following discussion, assume that the pitch servo is on (“**V NAV**” servo LED is illuminated) and the Pro Pilot is in the **ALT HLD** mode.



Pressing the **V MODE** button once will bring up the **VS SET** screen. With this display present, rotate the encoder knob to dial in a climb or descent rate.



With the **VS SET**, the rotary encoder provides a means to set in a climb or descent in increments of 100 feet/sec. Note that the display now indicates the VS mode is armed (**ARM**)

Rotating the encoder clockwise increments the vertical speed display to show a positive rate of climb, while rotating the encoder to the left will set in a descent. On the screen to the above, the rate indicates that a positive 800 feet per minute has been entered as the desired climb rate.

 Please note that the climb will not begin until the pilot presses the encoder knob to activate the climb. If a preselected altitude has been activated the **VS XXX** display below will have a “**P**” appended behind the “**VS**” and will read “**VSP XXX**” – see Altitude Pre-Select Function (**ALT SEL**)



If the encoder knob is now pressed, the **ALT HLD** LED will turn off and the **AS/VS** LED will illuminate and the display screen will show **VS ACT** (Vertical Speed Active). The aircraft will then begin a climb at the selected rate. (The **ALT SEL** LED may also be illuminated if there is an active preselected altitude)



If the Pilot wishes to pause the climb/descent, momentarily pressing the encoder knob will invoke the **VS SUSP** (vertical speed suspend) mode and place the system in **ALT HLD**. The **VS** LED will extinguish and the **ALT HLD** LED will illuminate. Once this is done, the aircraft will level off and the display will again display **VS SUSP**. However, the selected vertical rate is still in the display indicating that the climb may be resumed by pressing the encoder knob again.

If the pilot wishes to cancel the selected vertical rate, it may be done by pressing (and holding) the **V MODE** button for 3 seconds. This will cause the **AS/VS** LED to turn off (if ON), and the autopilot will enter the **ALT HLD** mode. Any vertical speed (or altitude settings) that have been previously entered will be canceled.

If the Pro Pilot is commanding a climb to an assigned altitude of 10,000 ft and a controller asks the pilot to temporarily hold at 6,000 ft., the pilot may press the encoder button upon reaching 6,000 ft and the aircraft will hold at that altitude. When cleared to continue the climb, the pilot may press the encoder button again to resume the climb. Alternatively, the pilot may set the **VS climb rate** to zero at 6000 ft which will then hold that altitude until the vertical rate is changed.

NOTE: The pilot may change the vertical rate even while the aircraft is climbing or descending. Rotating the encoder knob while on the **VS SET**, **VS ARM**, **VS SUSP** or **VS ACT** screen will allow the pilot to increase or decrease the climb or descent rate setting.

For instance, if you are descending toward a destination airport at, say, 500 feet per minute and see that you need to steepen your approach to arrive at the approach end of the runway, you might rotate the encoder knob to change the descent rate to 700 ft/min.

Altitude Pre-Select Function (ALT SEL)

The pilot may pre-select a destination altitude. When engaged, the system will command the aircraft to climb or descend to the selected altitude. Upon arrival at the destination altitude, the system will automatically switch to the **ALT HLD** mode and assume level flight.



To work properly, the Pro Pilot must start with accurate altitude information. Once the pilot has adjusted the baro setting on the aircraft altimeter, the **ALTITUDE** setting in the Pro Pilot may be easily adjusted to agree with the aircraft altimeter by repeatedly pressing the **V MODE** button to display the **ALTITUDE SET** screen and changing the altitude setting by rotating the encoder knob.

When initiating a climb or descent to a destination altitude, the Pro Pilot will begin the climb/descent at either the rate set by the pilot, or a default vertical speed that has been predetermined in the **PREFERENCES** menu.

The factory preset is 500 fpm, but this may be changed by the user.

Once the climb or descent is under way, the display will show the **VSP ACT** screen. Here, the pilot may adjust the current climb/descent rate to a different vertical speed as conditions demand.

NOTE: A vertical rate and destination altitude may be entered prior to engaging the **V NAV** servo: e.g. prior to takeoff. Once these parameters have been entered, and **VS SUSP** (or **VSP SUS**) is displayed, the aircraft will immediately enter a climb when the **V NAV** servo is engaged.

Entering the Current Altitude

For the altitude pre-select function to be accurate, it is important that the system be set to the current local barometric pressure. Just as the primary aircraft altimeter must be adjusted to compensate for barometric pressure changes, the Pro Pilot also provides a means for making such adjustments. While the primary aircraft altimeter is adjusted using a scale calibrated in “inches of mercury” (e.g., 29.92), the Pro Pilot is adjusted to agree with the altitude shown, in feet, on the corrected primary altimeter.

Barometer Elevation/Altitude Set



If the aircraft is on the ground when the Pro Pilot system is turned on the display screen will show the **ELEVATION SET** display and indicate the assumed field elevation.

The initial **barometric elevation** should be set to be as close to that of the airfield elevation as possible. Rotating the encoder knob will change the baro elevation in 5-foot increments, and it should be set to be as close to the actual airfield elevation as possible. This will assure that the internal Pro Pilot system altimeter will agree closely with the aircraft altimeter that has also been corrected to airfield elevation.



If the aircraft is in flight when the Pro Pilot is first turned on, the screen will show the **ALTITUDE SET** display and indicate the assumed altitude as shown.

If this does not agree with the baro corrected primary aircraft altimeter, rotate the encoder knob to enter the proper altitude. The aircraft should be level (not climbing or descending) so that the aircraft altimeter needles are not moving. The system is now calibrated and ready to use. Press the encoder knob to exit.

Once the altitude has been set, it can be accessed and changed at any time. To see the **ALTITUDE** screen in flight, press the **V MODE** button repeatedly and the display will increment as follows:

ALT HLD - SET VS - ALT SET - ALTITUDE



ALTITUDE SET function in this mode.

The **ALTITUDE** screen may then be changed by rotating the encoder until the indicated altitude agrees with the aircraft altimeter. The display resolution is in 20-foot increments for the



In normal flight, unless remarkable barometric changes have been experienced, the **ALT ACT** display should also agree with the current altimeter indication.

Press the **V MODE** button to return to the active screen.

Note: The mechanical aircraft altimeter is subject to small errors at different altitudes and should be calibrated according to FAA guidelines. The Pro Pilot contains an accurate model of the atmosphere but may exhibit small errors attributed to normal manufacturing tolerances of the precision sensors. Such accumulated errors between the two systems will typically be less than 1%. During rapid climbs and descents, it may also be observed that the mechanical altimeter “lags” the Pro Pilot altimeter **ALTITUDE SET** due to the faster response of the solid state sensors.

Entering a Destination Altitude

NOTE – in the following descriptions if the altitude preselect function is not activated, sequencing to the **ALT SET** screen forces a snapshot of the current altitude into the **ALT SET** screen. For example, assume you are in a climb and set a preselected altitude, but do not activate the preselect function. Then you sequence back around to the **ALT SET** screen. When you select the **ALT SET** screen the current altitude will be selected and the original setting will be discarded.

To enter a destination altitude, press the **V MODE** button to toggle to the **ALT SET** screen and rotate the encoder knob to select the desired altitude.



Let's assume that we wish to climb to 7,500 feet. Rotating the encoder knob will increment the value by 100 ft. per click. Pressing and rotating the knob will increment the value by 1,000 ft. per click.

When the knob is rotated to enter the altitude, the message will change from **ALT SET** to **ALT ARM** and the screen will show the selected altitude. Once the proper altitude is entered, press the encoder knob to activate the climb to altitude.

NOTE: If a climb/descent rate has previously been set in the **SET VS** screen, the climb/descent to altitude will be at the rate that was entered. If no vertical rate was entered the default rate (specified in the **PREFERENCES** menu) will be automatically used.

Before initiating the altitude change, the display screen will show the **ALTITUDE** set screen so the pilot can check the Pro Pilot altimeter against the aircraft altimeter. If the autopilot altimeter does not agree with the aircraft primary altimeter, adjust it to agree by rotating the encoder knob. Once the aircraft altitude is confirmed or adjusted the pilot must press the encoder again and the climb will begin. The display screen will show the default climb or descent rate.

NOTE: During the climb, BOTH the **AS/VS** LED and the **ALT SEL** LED will illuminate. This informs the pilot of the active modes, even if the pilot has pressed the **H MODE** button to view only horizontal navigation information on the screen.

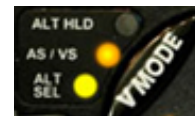

Once at the destination altitude of 7,500 feet, the system will enter the **ALT HOLD** mode and the aircraft will level off and hold that altitude.

- To cancel the pre-selected altitude (but not the vertical rate), press the **V MODE** button until the display shows the **ALT ACT** screen and then press and hold the encoder knob for 3 seconds.

The **ALT SEL** LED will turn off and the destination altitude will be canceled, but the climb or descent will continue at the rate selected. The **AS/VS** LED will continue to be illuminated.

- To cancel both the destination altitude and the vertical rate, press and hold the **V MODE** button for 3 seconds.

Both LEDs will turn off and the green **ALT HLD** LED will illuminate as the aircraft maintains that altitude.

Pausing the Climb Example

During the climb to a destination altitude, a controller might ask the pilot to hold at a specific altitude until further advised. The Pro Pilot can easily accommodate such a request.

Example: Assume that a climb has been initiated to a destination altitude of 8,500 feet. The **AS/VS** LED and the **ALT SEL** LED are on to indicate the active profile. If it is desired to pause the climb at, say, 6,500 feet the pilot may press the encoder button (while viewing any **V MODE** screen and the display arrow points to the right) when the aircraft reaches 6,500 feet.

At that point, the Pro Pilot will enter the **ALT HLD** mode and the green **ALT HLD** LED will illuminate to inform the pilot that the aircraft is holding at the current altitude. The **AS/VS** LED and the **ALT SEL** LED will extinguish.

To resume the climb to 8,500 feet, press the encoder knob to initiate the climb and the **AS/VS** LED and the **ALT SEL** LED will again illuminate and the **ALT HLD** LED will extinguish.

NOTE: A vertical rate and destination altitude may also be entered *prior* to engaging the **V NAV** servo. Once these parameters have been entered and activated, the aircraft will immediately enter a climb or descent to the preselected altitude, if chosen, when the **V NAV** servo is engaged.

Upon reaching 8,500 feet, the aircraft will resume level flight and the **ALT HLD** LED will illuminate.

Assuming that the aircraft was trimmed properly for the climb, the display will begin to display a “**TRIM DN**” alert when the aircraft levels at the “paused” altitude.

Changing the Destination Altitude

If the pilot wishes to change the destination altitude, once set, prior to initiating the climb or during the climb, it is easily done by repeatedly pressing the **V MODE** button until on the **ALT SET (ALT ACT)** screen. Rotating the encoder will then change the destination altitude.

Example: If a controller has cleared the aircraft to climb to 5,500 feet, the pilot might go to the **ALT SET** screen and enter that altitude. (Pressing the encoder will set the climb command and the screen will automatically advance to the **ALTITUDE SET** screen where the pilot can assure that the altitude shown agrees with the primary aircraft altimeter. Pressing the encoder again will initiate the climb). If a specific climb rate was not entered, the Pro Pilot will enter the default climb rate that was chosen in the **PREFERENCES** menu.

Once in the climb, if the controller then changes the assigned altitude to 7,500 feet the pilot would press the **V MODE** button repeatedly until on the **ALT ACT** screen, rotate the encoder knob until the destination altitude reads 7,500, and then press the **ENCODER** to activate the new altitude. It is not necessary to perform any other action to activate that setting.

A Vertical Flight Scenario

Let’s assume that we are flying to an airport that is about 50 nm distant. Our home airport is located under Class B airspace with a ceiling of 3,500 ft. Our enroute altitude is planned to be 7,500 ft. We have entered the route into our GPS and selected the localizer approach at the destination (if we have a panel mounted GPS).



ELEVATION SET
850

When we power up, the Pro Pilot asks us to adjust the **ELEVATION SET** screen so that the internal altimeter agrees with the field elevation.

Rotating the encoder knob will adjust the elevation by 5 ft. per “click”. Once the display altitude agrees with the aircraft altimeter, press the encoder knob and the screen will advance to the **H MODE** displays.



BTW 025 ◀ KXYZ
GTK 025 GS 0

The display indicates that the destination airport is KXYZ and, since we are still motionless on the ground, the groundspeed is zero.

Press the **V MODE** button to change to the **V MODE** display. The first display screen will show an **MAN TRM / DN-UP** message.



BTW 025 ▶ VS SET
GTK 025 0

Press the **V MODE** button again to advance to the **VS SET** (set vertical speed) screen. When first entering this screen, the rate will always be “0” unless previously adjusted.



BTW 025 ▶ VS ARM
GTK 025 ▲800

Rotate the encoder knob to set in the desired climb rate – in this case let’s use 800 fpm. Note that the message now says **VS ARM** once the value is selected.



BTW 025 ▶ ALT SET
GTK 025 850

To enter the destination altitude, press the **V MODE** button again to advance to the **ALT SET** screen. Note that the system has “snapshot” our current altitude and

displays it on the screen. Since we are still on the ground, it will show the same field elevation that we had previously adjusted when we first turned the system on.

Rotate the encoder to enter the desired altitude. Each “click” of the encoder will change the altitude by 100 feet. If we press and hold the encoder knob while turning, it will change the altitude by 1,000 feet per “click”.



Select the destination altitude of 7,500 feet as shown, and press the encoder knob to enter this value. If the encoder is not pressed, the value will not be entered.

After pressing the **ENCODER** button, the **ALTITUDE** screen will be displayed. If the **ALTITUDE** is correct, press the **ENCODER**. Once pressed, **VSP SUS** will be displayed along with the 800 ft/min climb rate in the bottom field.

The Pro Pilot is now properly set for the flight. The GPS has a flight plan and the climb rate and destination altitude have been entered.

After takeoff, and safely out of the airport traffic pattern, we engage the **H NAV** servo by pressing the **H NAV** button. The Pro Pilot is now controlling the lateral navigation and guiding the airplane toward the destination airport.

Assume that we are still close to our departure airport and the class B airspace is still above us. At this point we can engage the vertical profile by pressing the **V NAV** button. This engages the pitch servo and the aircraft will begin to climb. Pressing the encoder knob, once close to the Class B floor, will “pause” the climb so that we remain below the restricted airspace.

The **ALT HLD** LED is now illuminated and the other two **V MODE** LEDs are extinguished. This tells us that the aircraft is holding altitude and ready to climb to altitude.

The **VSP** message now says **VSP SUS** (Vertical Speed/Alt Preselect are suspended).

Once clear of the class B airspace it is only necessary to press the encoder knob once again to resume the climb. At this point, the **ALT HLD** LED goes out and the **AS/VS** and **ALT SEL** LEDs illuminate, indicating that the climb is again active to the preselected altitude.

It is now possible to press the **H MODE** button to resume viewing the **H NAV** displays.

When the aircraft approaches within 100 feet of the destination altitude, it will slow the ascent to 200 feet per minute for a smooth intercept. When it reaches the destination altitude, it will level the aircraft and enter the **ALT HLD** mode. The **AS/VS** LED and **ALT SEL** LED will extinguish and the **ALT HLD** LED will illuminate.

Note: While the **HMODE** displays are active and when in a climb/descent to a destination altitude, the right-side display will normally show the **VS** screen indicating the climb or descent rate. As a reminder, at approximately 20 second intervals, the display will briefly show the destination altitude as well.



Here it indicates a climb to 7,500 feet.



Vertical Use of Pilot Command Steering

The Pilot Command Steering (**PCS**) function may be used to set a climb or descent rate. It is employed by pressing and holding the remote disconnect button on the control stick while the **V NAV** pitch servo is engaged.

This will disconnect the pitch servo from the controls and allow the pilot to establish a desired climb or descent. After 3 seconds, the **V NAV** servo LED will begin to flash. This indicates that the servo will re-engage when the button is released and the Pro Pilot will continue the climb/descent at the rate it detected when the button was released.

The pilot may elect to have the **PCS** climb/descent rate controlled by the vertical speed (**VS**) of the aircraft at the time of button release, or the airspeed. The choice between vertical speed (**VS**) or airspeed (**AS**) may be selected in the **PREFERENCES** menu. If the pilot chooses to employ a **PCS** climb rate based upon airspeed (possibly chosen for best cooling in a climb) the climb will continue at that airspeed but the vertical speed (**VS**) will change with altitude and power settings.

It should also be noted that the **PCS** function (when employed) will affect the **H NAV** mode as well. As previously described, it will put the Pro Pilot into the **CRS** mode and track the course that the aircraft is on when the button is released.

Trim Alerts



The Pro Pilot control head monitors the trim conditions of the pitch servo. When it detects that the aircraft is slightly out of trim (after the aircraft burns fuel over time, for instance) it will put a small arrow in the lower right corner of

the display, as shown. The arrow will point up if the pilot needs to adjust the trim up a bit and it will point down if a small amount of down trim is in order. Trim adjustments should be made in small increments, with a 5-10 second pause between each adjustment to allow the trim integrators to stabilize. When in proper trim, the arrow will not reappear.



Should the pilot command a climb or descent and not adjust the trim to reduce elevator forces, the lower right screen will display "TRIM UP" or "TRIM DN", indicating a greater trim requirement. In this instance, the pilot should apply trim

more assertively, again in short intervals, and monitor the screen until the alert is no longer present. Once the aircraft reaches the destination altitude and levels off, the trim will need to be readjusted or the warning will appear again. When this trim message appears an alert tone will sound.

Clutch Slip Alert



The Gold Standard servo employs a slip clutch that allows the pilot to overcome the servo forces in an emergency that does not allow time to disconnect the servo. Additionally, the servo clutch is adjusted so that it may slip when the

encounters heavy turbulence, thus reducing elevator forces that could be detrimental to the aircraft.

The clutch may also slip if the out-of-trim elevator forces become excessive when commanding climbs and descents without trimming the aircraft. This is a further reminder to the pilot to adjust the trim properly. A clutch slip message should not be viewed as an unusual event in moderate turbulence, when it may alert the pilot intermittently. However, if it appears for an extended period of time, such as in a climb or descent, it is a further reminder to the pilot to properly trim the aircraft. An alert tone will sound when the message appears.

If the aileron clutch slips, the clutch slip message will appear on the lefthand side of the display screen and a tone will sound.

Chapter 9

GPSS and GPSV Operation

GPSS and GPSV Defined

GPSS and **GPSV** are acronyms for “GPS Steering” and “GPS Vertical steering”. These features use the ARINC 429 data stream provided by IFR certified WAAS enabled GPS receivers.

When ARINC signals are available and the Pro Pilot is in the Track (**TRK**) mode, the autopilot follows the roll commands (**GPSS**) and vertical commands (**GPSV**) issued by the originating GPS receiver or EFIS.



In addition to the ARINC data, the Pro Pilot also requires the AVLINK RS-232 data input for other features and functions to operate properly.

The Pro Pilot can utilize the ARINC signal from non-WAAS GPS receivers and will accurately track a flight plan, as well as the lateral profile of certain GPS approaches. No GPSV data is available with a non-WAAS receiver.

GPSS and GPSV Considerations

- Precision GPS approaches (RNAV) require the use of an approach certified WAAS receiver to be able to fly the vertical profile of an approach. Such WAAS receivers also provide guidance for the Pro Pilot to fly procedure turns and certain holding patterns.
- The IFR approved UPS GX series of GPS receivers have a GPSS type signal interface available on a dedicated RS232 channel into the autopilot, however no vertical (GPSV) capability exists with these receivers.

NOTE: The ARINC lateral and vertical guidance is only accepted from the GPS when the autopilot is in the **TRK** mode.

If the autopilot is placed in the **CRS** or **INT** modes:

- The ARINC input is disregarded
- The lateral and horizontal flight paths are selected at the autopilot front panel
- Lateral navigation reference is provided via the RS-232 AVLINK signal
- Vertical guidance is selectable at the autopilot based on the static system barometric pressure data and by selection of the **AS/VS** or **ALT HLD** modes.

Operation Using Certified WAAS GPS Receivers

Certified panel mounted WAAS GPS receivers have proven accuracy that allows them to be used for precision GPS approaches into airports, as well as en route navigation.

GPSS Guidance

When an approach certified WAAS enabled GPS receiver is used, the Pro Pilot will follow the ARINC roll commands to the extent that it will fly complete horizontal flight plans (as entered into the GPS receiver), including procedure turns and holding patterns.

For GPSS guidance to be active two conditions must be met:

- The **H MODE** selection must be in the **TRK** mode to allow the ARINC signal to be processed.
- The blue **GPSS LED** must be illuminated (indicating a valid ARINC 429 signal being received) and the autopilot is in the Track (**TRK**) mode.

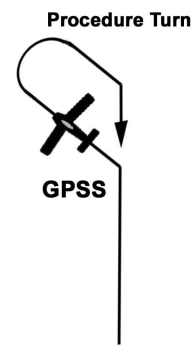



When the **GPSS** is available from the GPS receiver, the Pro Pilot will always default to the **GPSS** mode when valid data is present and in the **TRK** mode.

GPSS LED Indicator

- In the event that the **GPSS** becomes inactive (i.e. on a localizer approach) the **GPSS LED** extinguishes and the Pro Pilot immediately begins to track the Aviation Data (AVLINK) signal that it receives on the RS-232 data input line.
- If the pilot presses the **H MODE** and selects the **CRS** or **INT** mode the blue **GPSS LED** will flash at a one second interval. This indicates the Pro Pilot is no longer using the ARINC signal for guidance and is now relying on the RS232 signal for the course and intercept functions.



Since the **GPSV** does not function without the **GPSS**, the **GPSV LED** will also flash once per second, and vertical guidance will be controlled by the front panel of the Pro Pilot.

NOTE: When the **GPSS** and /or the **GPSV** LEDs flash once per second this indicates that the **GPSS** and/or **GPSV** data is available, but is not being used due to the autopilot not being in the **TRK** mode, or the servo is not ON. Putting the Pro Pilot into the Track (**TRK**) mode will again activate the **GPSS** and **GPSV** guidance.

GPSV Guidance

An approach certified WAAS GPS system allows vertical tracking of RNAV descents into approved airports.

This **GPSV** function will not be active during the en route portion of a flight plan and becomes active only when the WAAS GPS is configured for the approach and the final approach is initiated. At this point, the receiver recognizes that the approach is valid and provides the proper data signal to the autopilot for vertical navigation.

Approaches:

Note: While the autopilot has the following capabilities, limitations for approaches may have been imposed by the FAA. Check the AFMS (Aircraft Flight Supplement Manual) for your particular aircraft on the web site of The STC Group, LLC. (www.thestcgroup.com/documents)

- The approach will normally begin with the Pro Pilot in the **ALT HLD** (Altitude Hold) mode, although in some cases the autopilot VS may be in use.
- When the vertical data signal becomes valid, the blue **GPSV LED** will blink and the autopilot will be forced automatically to the **ALT HLD** mode. The blinking blue **GPSV LED** indicates that the Pro Pilot has identified the ARINC vertical tracking data, but it is not being used for guidance.



- At this time, the display screen will show the vertical distance to the descent path into the airport. The screen shown here illustrates that the descent line is just 420 feet above the aircraft

as it intercepts. The aircraft will command a “bend over” pitch down just prior to intercept so that it doesn’t overshoot the line.

In the display shown, the top left field is the active waypoint identifier (KCRQ) while the lower left field is the range to (or from) that waypoint (8.9 NM). The top right field is the crosstrack error relative to the virtual localizer (right of track 0.01 NM).

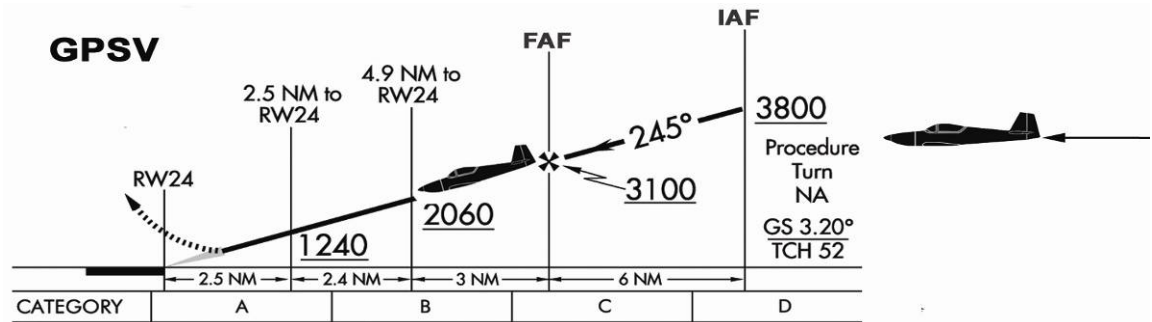

When the aircraft intercepts the descent line,

- The **GPSV LED** will glow steadily.
- The autopilot **V MODE** indicator will automatically change to the **AS/VS** mode (**AS/VS LED** will illuminate) and begin the descent.
- The display screen will continue to show the vertical and horizontal tracking accuracy.

In most cases, ATC will assign your intercept altitude well below the glideslope descent line. The aircraft flight path will be such that the aircraft intercepts the descent path from below the line.

However, the autopilot will allow as much as a 500 foot above the line intercept condition. In this case the ARINC vertical tracking data will become immediately active when the aircraft is positioned above the descent path. The autopilot will now command an immediate “bend over” to intercept the descent path.

NOTE: If the aircraft path is more than 500 feet above the descent path the approach will be immediately terminated, and the autopilot will flash an abort message and enter **ALT HLD** until the vertical servo is disengaged or power cycled.

Unusual Conditions

Although it is impossible to list all the various failure modes that can occur with multiple complex systems, some points are worthy of note.

1. Under any condition, turning off the Pro Pilot servos positively returns control of the aircraft to the pilot. This can be accomplished via the servo buttons on the face of the bezel, the remote autopilot disconnect switch, or by removing power from the autopilot.
2. Selecting the **CRS** or **INT** mode on the autopilot positively disconnects the autopilot from the ARINC inputs.
3. If there are multiple ARINC or RS-232 sources available, installing a selection switch allows the Pro Pilot to independently access each source. If the primary signal source fails, the pilot can quickly select an alternative such as using the data signal from a portable GPS receiver. If this scheme is employed you must ensure that the RS232 serial data and the ARINC 429 data are always selected from the same source.

Example Approach Scenario

For purposes of illustration, assume we are cruising in the en route mode, the Pro Pilot is using the ARINC 429 data for roll steering commands and is in altitude hold mode at 4,500 feet. The destination is Palomar Airport in Carlsbad, California (a sample approach chart is shown on the following page).

In this case we are using an approach certified WAAS receiver.

The approach plate shows two possible initial approach fixes (IAF), GAYGE and ICUGA. There is an intermediate fix (IF) at KANEC intersection and a final approach fix (FAF) at JABAL. If we begin our approach at ICUGA, the chart shows that we must not descend below 3800 feet as we transition to KANEC. The chart also stipulates that we must remain above 3100 feet between KANEC and JABAL.

After contacting approach control, we request the RNAV LPV approach using the ICUGA transition and the controller responds with instructions to remain above 4,000 feet until reaching ICUGA.

Approaching ICUGA, we use the Altitude Select (ALT SEL) mode on the Pro Pilot to set the destination altitude to 4,000 feet, with a descent rate of 500 feet/minute. Once the aircraft reaches 4,000 feet it automatically enters the Altitude Hold (ALT HLD) mode and continues the approach at that altitude.

Upon reaching ICUGA the aircraft turns and flies directly to KANEC.

We now slow the aircraft to approach speed. When we arrive at KANEC and begin the turn toward JABAL (still in ALT HLD) the GPSV LED begins to blink, that the ARINC 429 vertical deviation data signal has become active.

Note: If the Pro Pilot was not in the ALT HLD mode at this time, the ALT HLD mode is forced until the bendover occurs.

The R/H side of the display screen automatically changes to show the cross-track error in the top line of the screen, and the bottom line shows that the descent line is some 800 feet above the aircraft.

The aircraft remains in ALT HLD as it continues toward JABAL and the display screen shows that the vertical distance to the descent line is decreasing.



The screen to the right shows the line is now 420 ft. above the aircraft) and is tracking within .01 NM is the horizontal centerline.

The GPSV LED continues to blink until the descent line is just a few feet above the aircraft, at which time it begins to glow steadily and the Pro Pilot commands a “bend over” maneuver. The aircraft pitches down and begins to descend. The pilot immediately retards the throttle to remain at approach speed. The Pro Pilot will now direct the aircraft to remain on the lateral/vertical descent path to the airport.

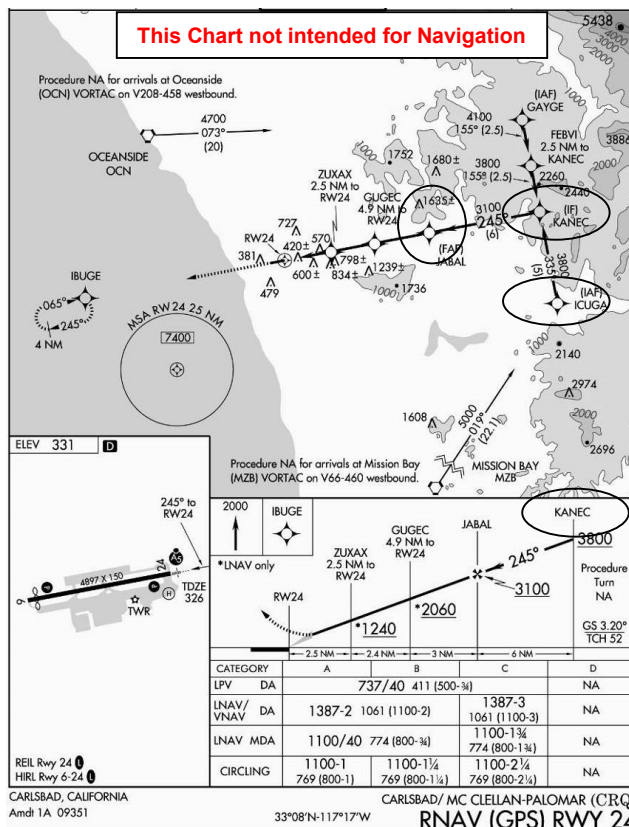

Chapter 10

Autopilot Preferences Menu

The Preferences Settings menus are designed to allow the pilot to set various flight options and selection used during flight.

Using the Preferences Menu

To enter the Preferences Menu, press and hold the encoder knob for a period of 3 seconds while in the navigation display. The navigation display will be replaced by the setup screens. Paging through the setup screens is accomplished by repeatedly pressing the encoder knob or by rotating the encoder knob.

Once the appropriate screen has been selected, press the **H MODE** button to activate the cursor and place the triangular arrow next to the value that is to be adjusted. Once the cursor is in place, rotate the encoder or, in some cases, press the encoder to change the value. The value will not change if the triangular arrow is not present on the display screen.

To exit that screen, press the **H MODE** button until the cursor is no longer present on the display. It is now possible to use the encoder to page through the setup screens.

To exit the menu, press and hold the encoder knob for a period of 3 seconds and the screen will return to the navigation functions.

Settings Available in the Preferences Settings Menu

- **CRS MODE SELECT** - Used for G5 / Aspen or normal CRS mode operation selection
- **BACKLIGHT and DISPLAY SET** – Sets the brightness levels if the remote dim isn't used
- **DISPLAY BRIGHT SET** – Sets the display brightness for the OLED display screen
- **FL DIST, FL TIME** – Displays re-settable flight distance and flight time
- **TOT DIS, TOT TIME** – Display non-resettable total distance and total time
- **CIRCLE LAST WPT?** – Sets the option to circle the last flight plan waypoint or to proceed on prior course thereafter
- **SET_DEFAULT VERT RATE** – Allows selection of the default vertical rate
- **AS/VVS SELECT** – Sets the airspeed capture (AS) or vertical speed capture (VS) option for PCS
- **MAX TURN RATE** – Sets the automatic or manual maximum turn rate
- **ZERO FLT DATA ON POWER UP** - allows automatic reset of the **FLIGHT TIME** and **FLIGHT DISTANCE** on each power up sequence
- **Custom Startup screen Display setting** – Allows configuration of the custom startup screen
- **Autopilot software version and serial number**– Provides the firmware version and the unit serial number for factory reference

Backlight Set and Display Brightness Set

The **BACKLIGHT SET** controls the backlighting of the indicators, LED's and buttons. It allows setting the level of the panel nomenclature if the remote analog dim (panel dimmer) interface is not being used. The **BACKLIGHT SET** setting has nine levels of intensity with a setting of 1 being the dimmest setting.

The **DISPLAY BRT** value adjusts the brightness of the characters that appear on the OLED screen. This setting also has nine levels of intensity with a setting of 1 being the dimmest setting. **NOTE:** When the external dimming feature is employed (using the aircraft panel dimmer) a maximum of 8 levels is available.

To enter the **BACKLIGHT SET** and **DISPLAY BRT** selections perform the following steps:

1. Enter the **PREFERENCES SETTINGS** menus as detailed previously and select the **BACKLIGHT SET** and **DISPLAY BRT** menu.
2. Press and release the **H MODE** button. The arrow will be placed to the left of the **BACKLIGHT SET** value.
3. Rotate the encoder to change the value.
4. Press and release the **H MODE** button to advance the cursor to the **DISPLAY BRT** value.
5. Rotate the encoder to adjust the brightness of the OLED display screen
6. Press and release the **H MODE** button again to remove the cursor from the screen.



BACKLIGHT SET ▶ 1
DISPLAY BRT = 1

The procedure is complete and the encoder can now be used to select another menu screen.

Flight Distance and Flight Time

The flight distance and flight time (**FL DIST**, **FL TIME**) displays accumulate flight time and flight distance when a speed of 45 knots or above is maintained. These counters can be individually reset to zero at any time by selecting the appropriate display line and then pressing the encoder button to perform the zeroing.

For these timers to operate, the host GPS must be on and have achieved satellite lock. The time and distance information is saved in non-volatile memory once per minute so that, if power is lost momentarily, a maximum of only 1 minute of time and distance information will be lost.

The flight distance counter measures actual distance flown, including excursions from the programmed flight plan. For example, if you flew a 50 mile detour between two waypoints 200 miles apart, the actual distance added to the distance counter will be 250 miles.

All distance measurements are based on nautical miles so it is recommended the host GPS receiver be programmed to measure the distance in nautical miles vs. statute miles or kilometers.

The flight time counter measures actual flight time when the airspeed exceeds approximately 45 knots, as measured by the GPS.

The flight time or distance may be zeroed using the procedure below.

1. To enter the **FL DIST**, **FL TIME** selection, perform the following steps:
2. Enter the **PREFERENCES SETTINGS** menus as detailed previously and select the **FL DIST**, **FL TIME** menu.
3. Press and release the **H MODE** button. The arrow will be placed at the **FL DIST** setting value. To zero this value, press and release the encoder knob.
4. Press and release the **H MODE** button. The arrow will be placed at the **FL TIME** setting value. To zero this value, press and release the encoder knob.
5. Press and release the **H MODE** to exit this function.



FL DIST ▶ 212.3
FL TIME 02.15

The **FL DIST**, **FL TIME** procedure is complete and the encoder can now be used to select another menu screen.

Accumulated Total Distance, Total Flight Time

This display shows the total accumulated flight time and total accumulated flight distance (**TOT DIS**, **TOT TIME**) in nautical miles. It is informational only and cannot be reset. The values are saved once each minute during flight in nonvolatile memory.



TOT DIS 1880.3
TOT TIME 17.2

Circle Last Waypoint Setting

This selection allows you to either home to the last waypoint in a flight plan or GOTO waypoint, or to track outbound from the last waypoint.

- If the option is set to **NO**, the Pro Pilot will track directly outbound from the last waypoint in a flight plan, or the GOTO waypoint. The waypoint identifier will be placed in the lower left display line upon waypoint passage and will flash for 10 seconds to indicate passage.
- If the option is set to **YES**, the Pro Pilot will turn the aircraft to effectively “home” to this last waypoint. Both modes remain in their respective states until the **HNAV** mode of the Pro Pilot is changed, or a new waypoint is selected.

To set the **CIRCLE LAST WPT** selection, perform the following steps:

1. Enter the **PREFERENCES SETTINGS** menus as detailed previously and select the **CIRCLE LAST WPT?** screen.
2. Press and release the **H MODE** button. The arrow will be placed at the **YES (NO)** field
3. Rotate, or press the encoder to change the selection
4. Press and release the **H MODE** button.



CIRCLE LAST WPT?
▶ NO

The **CIRCLE LAST WPT?** procedure is complete and the encoder can now be used to select another menu screen.

Set Default Vertical Speed Rate

Upon activation of the altitude preselect function, either the vertical rate set into the **VS SET** display, or a default vertical rate will become active. If no vertical rate is set when the altitude preselect function is activated, the vertical default rate will be used for either the climb or descent to the desired altitude. The following procedure sets that default vertical rate.

To set the **SET DEFAULT VERT RATE** selection, perform the following steps:

1. Enter the **PREFERENCES SETTINGS** menus and select the **SET DEFAULT VERT RATE** menu.
2. Press and release the **H MODE** button. The arrow will be placed at the rate setting field
3. Rotate the encoder to change the selection.
4. Press and release the **H MODE** button.



SET DEFAULT VERT
RATE = 500



SET DEFAULT VERT
RATE ▶ 800

The procedure is complete. The encoder may be used to select another screen.

Selecting Airspeed or Vertical Speed for PCS

The AS (airspeed)/VS (vertical speed) select screen allows setting of the mode of the PCS steering function.

When the **PCS** mode is activated (by pressing and holding the servo disconnect switch for greater than 5 seconds while the servos are active) the autopilot could be placed into one of three different modes.

- If the selection is to **VS** and the vertical rate is in excess of 200 feet per minute, either up or down, then the autopilot will capture the current vertical rate.
- If the selection is to **AS**, and the vertical rate is in excess of 200 feet per minute, either up or down, and the then the autopilot will capture and maintain the current indicated airspeed. *This is useful for maintaining a constant airspeed for engine cooling in a prolonged high power climb condition.
- If the vertical rate is less than 200 feet per minute in either selection, then the **ALTITUDE HOLD** mode will become active.

To set the **AS** or **VS** selection, perform the following steps:

1. Enter the **PREFERENCES SETTINGS** menu as detailed previously and select the **AS/VS SELECT** menu.
2. Press and release the **H MODE** button. The arrow will be placed at the **AS(VS)** field.
3. Rotate, or press the encoder to change the selection.
4. Press and release the **H MODE** button.



The **AS/VS SELECT** procedure is complete and the encoder can now be used to select another menu screen.

Setting Maximum Turn Rate

A “standard rate turn” of 3 degrees per second may result in a comfortable bank angle at 130 knots, but as speed increases the bank angle must be increased to achieve the standard rate of turn.

In faster aircraft this steeper bank may be uncomfortable to some pilots and, indeed, may exceed the capability of an altitude hold system to maintain altitude properly in the turn. To remedy this, the Pro Pilot has a means whereby the users can adjust the maximum rate of turn to their personal satisfaction.

When shipped, the Pro Pilot is defaulted to an “automatic” mode where the actual turn rate is automatically adjusted based on groundspeed (as measured by your GPS) to limit the bank angle to approximately 15 to 20 degrees. For aircraft cruising at groundspeeds of 140 knots or greater the automatic mode will decrease the allowable turn rate to keep the aircraft bank angle at a comfortable maximum of approximately 15 degrees. Slower speeds will allow a standard rate turn of 3 degrees per second.

Alternatively, if your cruise groundspeed is typically less than 150 knots, or if you do not mind the higher bank angles at the higher groundspeeds, you may want to select the **MANUAL** mode. In the **MANUAL** mode you can set the maximum turn rate to a fixed limit. It is adjustable from 1 degree/sec to as high as 3 degree/sec, in increments of 1/10th degree/sec.

To set the **TURN RATE** selection, perform the following steps:

1. Select the **MAX TURN RATE** menu.
2. Press and release the **HMODE** button. The arrow will be placed at the **AUTO (MAN)** field
3. Rotate, or press the encoder to change the selection between **AUTO** and **MAN**
4. If a manual rate is desired, select the **MAN** field and then press and release the **HMODE** button. You may take this number as low as 1 degree/sec, but be advised that this will result in very slow turns and autopilot performance may be unacceptably sluggish. If **AUTO** is desired, select **AUTO** then proceed to step 6
5. With the arrow selecting the manual rate, rotate the encoder to select the desired rate
6. Press and release the **HMODE** button.



Custom Startup Display Screen

This screen is designed to provide a message of your choosing at power up. There are two lines of 16 characters each available for custom programming. The screen may show a Trio Avionics logo and firmware number, but this may be changed by the user.



Typically, most Pro Pilot customers place their name on the upper line of the display and the aircraft model and tail number on the second line. This display can be changed at any time to any configuration desired.



Press the **H** or **V MODE** button to position a flashing cursor at the first character position. The front panel switches function as follows:

- **Rotary Encoder** - Selects the displayed character from a set of available characters.
- **Encoder Pushbutton** - Selects the cursor position. The cursor will wrap around from the last character position on line 2 to the first character position on line 1.
- **H or V MODE button** - Terminates writing to the screen and removes the cursor from the screen.

NOTE: The characters are written to non-volatile memory as each character is changed. If you accidentally sequence out of this screen (or turn off power) whatever information that was present on the screen at that time will be retained in memory.

Zero Flt Data on Power Up

This **PREFERENCES** menu selection allows automatic reset of the **FLIGHT TIME** and **FLIGHT DISTANCE** on each power up sequence. The factory default is **"NO"**, but if the user wishes to have this reset automatically for each flight, it should be set to **"YES"**.

The selection is enabled by pressing the **HMODE** button which places an arrow next to the variable field (**YES/NO**). Rotating or pressing the **ENCODER** changes the **"YES/NO"** variable. The selection is exited by pressing the **HMODE** button which erases the arrow and returns the encoder function to display selection.

To prevent a momentary loss of power (while in flight) from resetting the values, the autopilot monitors airspeed and will not allow an automatic reset while in flight.

Note: The **TOTAL TIME** and **TOTAL DISTANCE** values are not affected if this option is enabled.

Autopilot software version and serial number

This screen is fixed and cannot be altered. It contains a permanent record of the manufacturer software version and device serial number. This data should be available if calling Trio Avionics for questions or service information.

Chapter 11

Dynon SkyView HDX, Aspen Pro Max, Aspen E5 and Garmin G5

This software release integrates the Dynon Skyview HDX, Aspen Pro Max, Aspen E5 and Garmin G5 – hereafter called **Remote Equipment**. All added functionality is described in this chapter.

NOTE: In all references below the autopilot MUST be in the CRS or TRK mode for the remote equipment to control the autopilot in course heading or altitude. Selection of the autopilot TRK mode disables remote course or heading equipment control but altitude control remains available.



Whenever the autopilot is connected to the remote equipment and the appropriate ARINC labels are sent by the remote equipment for barometric functions the autopilot front panel controls for **ELEV SET** and **ALTITUDE SET** are slaved to the remote equipment regardless of if the autopilot is in the CRS mode. The autopilot front panel controls for **ELEV SET** and **ALTITUDE SET** are disabled when the remote equipment is controlling these functions. The **TRK** and **INT** modes of operation have not been changed. The **CRS** mode is modified to use an external course or heading input from a remote device.

This software version allows remote control of the autopilot mode by the remote equipment via a source selection screen in the **PREFERENCES** menus. The autopilot lateral navigation can be remotely controlled by either the available remote heading bug or course bug depending on the **PREFERENCES-CRS MODE** menu selection. If corrected barometric pressure is available from the remote equipment, it will be used by the autopilot for altitude and preselected altitude overriding the internal autopilot altimetry functions. The information source from the remote equipment is the ARINC 429 Airdata bus.

The available control modes are:

- **AP CRS ENABLE**
- **EXT HDG ENABLE**
- **EXT CRS ENABLE**
- **AUTO ENABLE**



AP CRS ENABLE– This is the normal autopilot CRS mode if the remote is not part of the equipment suite, is not being used, or the selected input faults. This setting locks out the remote course, heading and altitude functions.

EXT HDG ENABLE - This selection allows the remote heading bug to select the heading input for autopilot control. SEE NOTE BELOW

EXT CRS ENABLE– This selection allows the remote course bug, or OBS to control the autopilot. SEE NOTE BELOW

NOTE

The **EXT HDG ENABLE** and **EXT CRS ENABLE** settings are primarily used to lock out a malfunctioning input. For example, if a magnetometer failed the heading would be unusable. Using the **EXT CRS ENABLE** setting ensures the heading is not available for lateral navigation

AUTO ENABLE– This setting allows automatic sensing of which input is being used for lateral navigation. If the remote equipment has both course and heading output functions control is passed to either one when the respective pointer is moved greater than **two degrees** from its static setting. For

example, assume the heading bug is being used to control lateral navigation. The pilot then decides he wants to fly a specific groundtrack (not heading). If the pilot then rotates the course bug greater than **two degrees**, control will shift to the course bug for lateral navigation.

In all cases if the course or heading input being used fails (data loss or data flagged as unusable) the autopilot will automatically discontinue using that data. Selection of the other input using the pointer will shift the input to the other data source.

OPERATION

PREFERENCES Menu Selection Procedure.



Enter the **PREFERENCES** menu by pressing and holding the **ENCODER** until the **PREFERENCES SETTINGS** display is visible.



Press and release the **H MODE** button. This puts an arrow on the screen next to the selected mode.



Press or turn the **ENCODER** to select the **HNAV** course mode input, either **AP CRS ENABLE**, **EXT HDG ENABLE**, **EXT CRS ENABLE**, or **AUTO ENABLE**.



Press the **H MODE** button to remove the selection arrow.



Press and hold the **ENCODER** to return to the normal operating mode.

Selected versus Slaved Functionality.

Operational Description.

EXT HEADING ENABLE selection

If this selection is active and the **CRS** mode is selected on the autopilot lateral navigation will now be controlled by the **heading pointer** on the remote equipment. If this selection is made in the **PREFERENCES** menu and the GPS signal is lost while the autopilot is in the **TRK** mode, the autopilot control will automatically shift to the REMOTE equipment heading input.

Several other internal operations are performed if this event takes place. First, the aircraft heading is snapshot to the commanded heading within the autopilot, so the aircraft stays on the heading it was on when the GPS data ceased. This is done to prevent a lateral navigation excursion if the remote heading bug is selected to some other heading when the failure occurs.



For example, assume the **TRK** mode GPS controlled aircraft groundtrack is 090 and the heading bug on the remote equipment was left at 210 from a prior heading control operation. In this case if a loss of GPS automatic shift to the heading mode was made without the above compensation the aircraft would start an immediate right turn to the selected 210 heading. With the compensation noted the aircraft would remain on the 090 heading. Once the pilot changes the selected heading on the remote equipment two degrees or more, the compensated mode is cancelled, and the actual heading bug selection is used.

When the **CRS** mode is selected on the autopilot and the **EXT HDG ENABLE** is being used the left side of the display will show **SEL XXX** on the top left field and **HDG YYY** on the lower left field. **XXX** is the remote heading bug value and **YYY** is the aircraft heading. The right side top and bottom fields remain as they were prior to this selection. In the event the GPS data is lost while using this mode the right-side displays will indicate **NO GPS** and display a rate-of-turn indication.

If the heading data from the REMOTE becomes invalid, the autopilot will revert to the normal autopilot **CRS** mode. In this case the top left label changes to **CMD XXX** and the lower left label changes to **GTK YYY**.

EXT COURSE ENABLE selection

If this selection is active and the **CRS** mode is selected on the autopilot the lateral navigation will now be controlled by the course pointer on the remote equipment. If this selection is made in the **PREFERENCES** menu and the GPS signal is lost while the autopilot is in the **TRK** or **CRS** mode, the autopilot will automatically use the remote heading for the tracking reference since GPS is the reference for the **EXT CRS ENABLE** selection and is no longer available. If the GPS fails when the selected course bug is being used the compensation used in the heading mode is not necessary since the course and heading will be similar or the same depending on the wind conditions.

When the **CRS** mode is selected on the autopilot and the **EXT CRS ENABLE** is being used the left side of the display will show **SEL XXX** on the top left field and **CRS YYY** on the lower left field. **XXX** is the remote course bug value and **YYY** is the aircraft GPS referenced ground track.

Aspen: In the event the GPS data is lost while using this mode the right-side displays will indicate **NO GPS** and display a rate-of-turn indication. The lower left field will still have the **CRS** label, but the value displayed will be aircraft heading.

G5: In the event the GPS data is lost while using this mode the top display line will indicate **NO GPS** and display a rate-of-turn indication.



Fault Modes

In the event there is a fault in either the GPS navigator or the Remote Equipment the following fault modes will take effect.

Remote equipment fails to provide heading data. Selected course is still operational, if available.

In this event the autopilot cannot use the **EXT HEADING** selection if selected on the autopilot. Therefore, the autopilot will shift functionality and use the selected course bug if the autopilot front panel **CRS** mode (not **TRK**) is selected. Also, since the selected

course bug on the autopilot might be pointed in an entirely different direction than the last heading pointer bug or GPS course being followed, the autopilot will automatically set the commanded course to the last heading bug angle received from the Remote Equipment. If the course bug is rotated in excess of two degrees from the position it was in when the heading bug failure occurred the ground track commanded by the pointer bug becomes valid and will be used to control the groundtrack of the aircraft.

GPS failure when using the course pointer for GPS course track. Remote heading still valid.

In this event the autopilot cannot use the **EXT COURSE** selection if selected on the autopilot. In this case the autopilot will shift functionality and use the selected heading bug if the autopilot front panel **CRS** mode (not **TRK**) is selected. Also, since the heading bug on the autopilot can be pointed in an entirely different direction than the last GPS course being followed, the autopilot will automatically set the commanded heading to the last valid GPS course. If the heading bug is rotated in excess of two degrees from the position it was in when the GPS failure occurred, the heading defined by the heading bug becomes valid and will be used to control the heading of the aircraft.

Remote Condensed Setup and Operating Procedures.

Enter the **PREFERENCES** menus and set the **CRS MODE** to either **AUTO ENABLE, AP CRS, EXT HDG ENABLE.**

Place the data selector switch (shown in Figure 1) to either the **EFIS** or **GPS** position. Assume it is in the **EFIS** position.

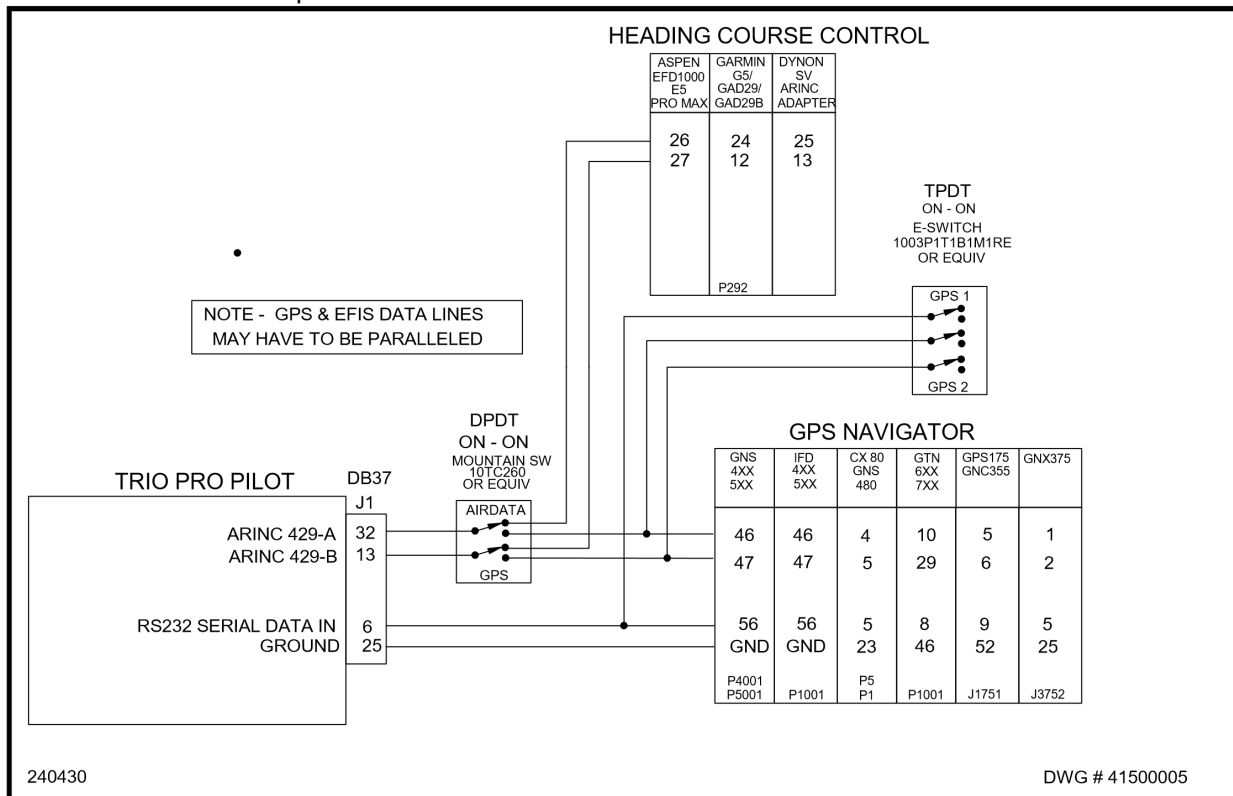

Figure 1

Place the Autopilot in the **CRS** mode. The top left field in the autopilot display will now read “**SEL**” which is the heading bug setting, and the lower left field will read “**HDG**” and display the aircraft heading received from the Remote Equipment. The AP is now connected to the Remote Equipment and will navigate the airplane in accordance with the heading bug. If the autopilot was set to **EXT COURSE** as previously described, the autopilot will follow the remote course pointer using GPS groundtrack as the tracking reference. The top left field in the autopilot display will now read “**SEL**” which is the course bug setting, and the lower left field will read “**CRS**” and display the GPS groundtrack from the GPS. Functionally this is identical to the autopilot **CRS** mode if **AP CRS** had been selected in step 6.a except the groundtrack is now being controlled by the course pointer on the Remote Equipment rather than the encoder on the autopilot.

NOTE: Whenever the autopilot is connected to the Remote Equipment the baro (altitude or elevation set) functions on the autopilot are slaved to the it. The controls for these settings on the autopilot are disabled when the remote is controlling.

NOTE: Functional operation of the Dynon SkyView HDX, G5, Aspen ProMax and Aspen E5 are the same for lateral navigation. The G5 and Aspen ProMax and Aspen E5 also have a SELECTED ALTITUDE function which is described in this section. The lateral navigation steps below illustrate the AUTO ENABLE setting in the PREFERENCES menu

Enter the **PREFERENCES** menus and set the **CRS MODE** to **AUTO ENABLE**

Place the data selector switch (shown in [Figure 1](#)) to either the **EFIS** or **GPS** position. Assume it is in the **EFIS** position.

Place the Trio Autopilot in the **CRS** mode. The top left field in the autopilot display will now read “**SEL**” which is the heading bug setting, and the lower left field will read “**HDG**” or “**CRS**” and display the aircraft heading or OBS setting received from the Remote Equipment. The AP is now connected to the Remote Equipment and will navigate the airplane in accordance with the heading bug or OBS bug.

NOTE: Whenever the autopilot is connected to the Remote Equipment the BARO (altitude or elevation set) functions on the autopilot are slaved the Remote Equipment. The controls for these settings on the autopilot are disabled when the Remote Equipment is controlling.

Operating procedures for **SELECTED ALTITUDE** operations.

If the connected remote equipment generates selected altitude and corrected baro the autopilot will process this input to control the aircraft altitude. The Remote Equipment described above has the **required labels** and therefore has the capability to control vertical climbs and descents. At power up the autopilot reads the value being transmitted by the Remote Equipment and saves this as the static reference altitude. The autopilot then continuously monitors the value of the selected altitude for a change from this static value. Once the value changes and remains stable for three seconds the autopilot accepts the new value as the new commanded altitude and will automatically perform the following functions. It will:

- Shift the autopilot display to the **VNAV** side (same as a first press of the **VMODE** button)
- Select the **VS** screen on the autopilot display

-
- Place the autopilot in the **VS** mode and activate a climb or descent at the default VS rate set in in the preferences menu.
 - Set and activate an altitude preselect at the new selected altitude on the REMOTE

Once activated the autopilot will climb or descend to the preselected altitude, then capture that altitude and go the altitude hold (**AH**) mode.

If the vertical speed setting needs to be changed in the climb or descent the pilot can adjust this using the encoder on the autopilot front panel. The **VS** display is already present. If the selected altitude is changed during the climb, it will become effective three seconds after the last change.

If the **PCS** function is invoked while in a climb or descent controlled by the Remote Equipment, the autopilot will use the remote equipment current heading or course when the **PCS** function is terminated (**PCS** button released). However, if the autopilot was in the **TRK** mode when the **PCS** was activated, it will shift to the normal AP **CRS** mode upon **PCS** release. The mode of the autopilot will shift to airspeed (**AS**) if the **PREFERENCES** setting specifies **AS**, or will remain in the **VS** mode if the **PREFERENCES SETTING** specifies **VS**.

Pressing and holding the **VMODE** button for three seconds cancels the climb or descent and the altitude preselect and sets the altitude hold (**AH**) mode

Chapter 11

Alerts, Warnings and Alarms

The Pro Pilot employs a number of sensors to monitor proper operation in the control electronics and the servos. When it detects a possible problem, it will notify the pilot via messages on the display screen and, if appropriate, via an audible alarm.

Alerts

Alerts notify the pilot when a non-critical event has occurred.

- **Servo Disconnect** – Sounds a three-beep- tone whenever the servo is disconnected intentionally or unintentionally.
- **BARO SET** – Requests the pilot to confirm the correct baro altitude before beginning a climb or descent.
- **Arrival at a Destination Altitude** – Sounds a single-beep tone and displays the message “**ALT CAPTURE**” for 5 seconds. The display then reads **ALT HLD**.
- **Trim Messages** – The display will present **TRIM UP REQD** or **TRIM DN REQD** when the autopilot is engaged and the aircraft is out of trim. The pilot should adjust the aircraft trim.
- **VS ERR** - The Vertical Speed error will appear when there is conflict between the Vertical Speed direction and the Altitude that has been selected. For instance, if the pilot dials in a 500 foot per minute descent but enters a destination altitude above the current altitude the servo will not engage and the error message will appear.

Warnings

Warnings alert the pilot of potential problems that may require action

- **NO GPS** – Indicates that the GPS signal has been lost. In this instance, the Pro Pilot will continue to keep the wings level, and continue using the barometric data for altitude control, but has no lateral navigation information.
- **NO FLT PLN** – GPS is available but no flight plan or GOTO has been entered. The Pro Pilot will enter the Course (**CRS**) mode and will fly a pilot selected course over the ground.
- **CLUTCH SLIP** - If the clutch slips for more than 3 seconds the message **CLUTCH SLIP** will appear. This warning may appear in severe turbulence, or in extreme out-of-trim conditions, if the servo must pull hard enough on the elevator that it causes the clutch to slip.
- **ALT ERR** - The “**ALT ERR**” message is displayed if the preselected altitude is above you and you have programmed a descent, or vice versa. When this occurs, it will execute the vertical rate command, but will not (cannot) capture the preselected altitude since the airplane is moving away from the programmed capture altitude.

Alarms

- **I/O ERROR** – This indicates a communication problem in the system, usually caused by a wiring error or a component failure. The servos will disconnect and a three-beep tone will sound.
- **SERVO CW LIM** – This will occur if the pilot pulls hard on the controls to slip the pitch servo clutch and force the servo crank arm to its clockwise limit. It will also occur if the servo is engaged while the elevator is in an extreme position. The servos will disconnect and an alarm will sound.
- **SERVO CCW LIM** – Same as above, but occurs when the servo crank arm is forced to its counterclockwise limit.